

# Waste Management in Squatter Communities in Costa Rica

An assessment of squatter communities and the development of human and solid waste management plans



Aaron Behanzin, Caroline Concannon, Olivia Doane, Mackenzie Ouellette



Sponsored by:



December 15, 2011

# **Waste Management in Squatter Communities in Costa Rica**

An assessment of squatter communities and the development of  
human and solid waste management plans

An Interactive Qualifying Project submitted to the faculty of  
WORCESTER POLYTECHNIC INSTITUTE  
in partial fulfillment of the requirements for the  
Degree of Bachelor of Science

Sponsoring Agency: Un Techo Para Mi País

Submitted to  
Mr. Daniel Mora and Mr. José Pablo Sandí: Un Techo Para Mi País  
Professor James Dempsey and Professor Jeanine Plummer: Worcester Polytechnic Institute

Submitted by

Aaron Behanzin  
Caroline Concannon  
Olivia Doane  
Mackenzie Ouellette

December 15, 2011

## **ABSTRACT**

Improper waste management in squatter communities in Costa Rica poses health risks to humans and degrades the environment. We worked with Un Techo Para Mi País to address the need for improved waste management in these communities. Using data on waste practices from site assessments, survey analysis, and personal communications, we developed a manual on feasible waste management options. For solid waste, a combination of composting, recycling, and municipal collection reduces waste volume at a reasonable cost. For human waste, composting latrines are low cost, use minimal space, and produce a usable product. We hope that these waste management strategies will improve living conditions in squatter communities in Costa Rica and throughout Latin America.

## ACKNOWLEDGEMENTS

We would like to extend our thanks to the following individuals and organizations for their support and contributions to the successful completion of this Interactive Qualifying Project:

- Un Techo Para Mi País (UTPMP) for sponsoring our project and providing us with the necessary resources to successfully complete our project
- Our sponsors, Mr. Daniel Mora and Mr. José Pablo Sandí, for their support and guidance throughout our project
- Mr. Mauricio Mora, for his help throughout the project with obtaining necessary documents in a timely manner
- Ms. María José Vasquez, Environmental Programs Coordinator, for providing her expertise with the organization and the communities
- Mr. José Antonio Aroyo and Mr. Arturo Gutierrez, UTPMP volunteers, for accompanying us on site visits and translating when necessary
- Ms. Paola Vidal Rivera, Environmental Engineering Laboratory Coordinator of the University of Costa Rica, for her expertise with wastewater management and taking the time to meet with us
- Ms. Alejandra Vargas for her guidance in translating our documents
- Mrs. Marcella Music and Mr. Jimmy Music for their guidance throughout the project and our experience in Costa Rica
- Mr. Andrey Rojas and Mr. A. Francisco Elizando for their support and help with translating when necessary
- The residents and community leaders of Barrio Nuevo, Cristo Rey, Vida Nueva, Guararí, and Ramal 7, especially Don E. Cerdas, for welcoming us into their community and providing information
- Professor Jeanine Skorinko, of Worcester Polytechnic Institute, for her guidance through the IRB exemption process and the organization of our data
- Professor James Dempsey and Professor Jeanine Plummer, of Worcester Polytechnic Institute, for their guidance and support throughout the duration of our project

## **LIST OF ACRONYMS**

**CIA** – Central Intelligence Agency

**CRC** – Costa Rican Colón

**DRFN** – Desert Research Foundation of Namibia

**INEC** – Instituto Nacional de Estadística y Censos de Costa Rica (National Institute of Statistics and Census of Costa Rica)

**PRODEL** – Programa de Desarrollo Local

**US EPA** – United States Environmental Protection Agency

**UN** – United Nations

**UNICEF** – United Nations Children’s Fund

**USD** – United States Dollar

**US CDC** – United States Centers for Disease Control and Prevention

**UTPMP** – Un Techo Para Mi País (A Roof for My Country)

**WEDC** – Water, Engineering and Development Centre (Loughborough University, Leicestershire, United Kingdom)

**WHO** – World Health Organization

**WPI** – Worcester Polytechnic Institute (Worcester, Massachusetts)

## EXECUTIVE SUMMARY

Squatter communities are settlements of people that do not rent or own the land on which they live and lack at least one of the three basic necessities: potable water, electricity, or improved waste disposal. Inadequate human and solid waste management can lead to adverse health effects, such as the transmission of diarrheal diseases, and environmental degradation. Un Techo Para Mi País (UTPMP) is a non-profit organization that is working on improving living conditions in squatter communities throughout Latin America. Our goal was to develop feasible waste management solutions for residents of squatter communities in Costa Rica in collaboration with UTPMP.

Our first objective was to assess current waste management practices and resource constraints in squatter communities. We conducted site assessments in five squatter communities in Costa Rica, interviewed community leaders, and analyzed resident surveys administered by UTPMP. From these data collection methods, we found that all five squatter communities lack improved sanitation services as defined by the WHO. Common sanitation practices in these communities are unlined pit latrines and pipes leading from the houses into the river. The pit latrines are often located less than 30 meters from a water source, which violates WHO standards. The squatter communities also lack proper solid waste management methods. Common methods of disposal are burning, informally dumping on land and in rivers, and illegally receiving irregular municipal trash collection. The average monthly income per household ranges from \$390 USD to \$730 USD among the five communities. Monthly municipal trash collection is quoted to be approximately \$5 USD per month per household in one of the municipalities. However, such trash collection is not reliable in squatter communities due to legality issues. Because squatter settlements are transient communities, the residents may be hesitant to implement a waste management solution when it is not guaranteed that they will see the long-term benefit.

Our second objective was to evaluate waste management strategies. We researched options for human and solid waste management based on criteria such as cost, ease of implementation, and ease of use. We summarized 14 feasible options in an implementation manual for UTPMP. We then provided recommendations for one rural community and one urban community. For both communities, we recommend a combination of recycling, composting, and

municipal collection for solid waste. This strategy would reduce the overall volume of waste and therefore the amount of environmental pollution. For human waste, we recommend ventilated two-vault composting latrines. Composting latrines do not require additional treatment of human waste, they produce compost, and they are permanent structures. Odors and fly problems are low and they require little maintenance. Compost from both solid waste and composting latrines can be reused without negative environmental impacts. It is also possible that compost can be sold.

We recommend that UTPMP updates the manual based on revisions made by the WHO and to account for fluctuation of material prices. Information regarding other methods of waste management should be included as the organization sees fit. In addition, we suggest that UTPMP adds information from their experiences with implementation of waste management strategies in squatter communities. UTPMP can use this manual throughout Latin America in the future to improve waste management in squatter communities.

## Table of Contents

Abstract .....	ii
Acknowledgements.....	iii
List of Acronyms .....	iv
Executive Summary .....	v
List of Figures .....	ix
List of Tables .....	x
Chapter 1: Introduction.....	1
Chapter 2: Literature Review .....	3
2.1 Geography of Costa Rica .....	3
2.2 Waste Management in Costa Rica.....	6
2.3 Squatter Communities .....	7
2.4 Un Techo Para Mi País .....	11
2.5 Health Implications .....	13
2.6 Case Study: Namibia.....	14
Chapter 3: Methodology .....	16
3.1 Community Assessment.....	16
3.1.1 Site Assessment .....	16
3.1.2 Surveys .....	17
3.2 Waste Management Manual.....	17
3.3 Waste Management Recommendations .....	18
Chapter 4: Results and Discussion.....	20
4.1 Current Community Practices .....	20
4.1.1 Cristo Rey .....	22
4.1.2 Vida Nueva .....	23
4.1.3 Ramal 7.....	24
4.1.4 Barrio Nuevo .....	27
4.1.5 Guararí .....	29
4.2 Community Waste Comparison .....	30
4.3 Developing Feasible Waste Management Solutions.....	33



4.3.1 Solid Waste Manual.....	34
4.3.2 Human Waste Manual .....	37
4.4 Community Selection .....	46
Chapter 5: Conclusions and Recommendations .....	47
5.1 Solid Waste Management Examples.....	47
5.2 Human Waste Management Examples .....	49
5.3 Future Recommendations.....	51
Glossary .....	53
Appendix A: WHO Sanitation Ladder.....	60
Appendix B: First Phase Survey Questions - Vida Nueva, Ramal 7, Barrio Nuevo, Cristo Rey.	61
Appendix C: First Phase Survey Questions - Guararí .....	63
Appendix D: Second Phase Survey Key - Cristo Rey, Vida Nueva, and Ramal 7.....	65
Appendix E: Second Phase Survey Questions - Cristo Rey, Vida Nueva, and Ramal 7.....	67
Appendix F: Second Phase Survey Questions - Guararí .....	70
Appendix G: Waste Management Manual.....	74

## LIST OF FIGURES

Figure 1: Annual average rainfall in Costa Rica.....	4
Figure 2: Provinces of Costa Rica .....	5
Figure 3: Shelters constructed with available materials in squatter community of Cristo Rey, Costa Rica.....	8
Figure 4: Squatter community of Barrio Nuevo, Costa Rica, located along a riverbank .....	9
Figure 5: Home built by UTPMP in squatter community of Ramal 7, Costa Rica .....	12
Figure 6: Disease transmission via the fecal-oral route .....	13
Figure 7: Dry sanitation Otji-Toilet system .....	15
Figure 8: Location of squatter communities .....	21
Figure 9: Solid waste burning in Cristo Rey.....	23
Figure 10: Solid waste accumulation in Ramal 7 .....	26
Figure 11: Private well in Ramal 7 .....	27
Figure 12: Open dump in Barrio Nuevo .....	28
Figure 13: River running through Guararí.....	30
Figure 14: Sanitation services in squatter communities .....	32
Figure 15: Composting cycle .....	36
Figure 16: Simple pit latrine .....	39
Figure 17: Ventilated improved pit latrine.....	39
Figure 18: Flush latrine .....	40
Figure 19: Septic tank diagram .....	43
Figure 20: Percolation trench diagram.....	44
Figure 21: Mor-sand filter diagram.....	45

## LIST OF TABLES

Table 1: Surveys conducted by UTPMP.....	22
Table 2: Common waste management practices.....	31
Table 3: Household monthly financial information from second phase surveys.....	33
Table 4: Summary of solid waste management options .....	35
Table 5: Latrine human waste management options.....	38
Table 6: Engineered human waste management options.....	42
Table 7: Numerical evaluation matrix for sanitation .....	50

## CHAPTER 1: INTRODUCTION

Many countries in Latin America have high poverty rates. According to the census conducted in July 2010, 24% of the total population of Costa Rica was impoverished. Of these, 28% were considered to be in extreme poverty, which is defined by the World Bank as living on \$1.25 USD a day or less. In these conditions, a person cannot afford his or her basic necessities, such as clean water, proper nutrition, and suitable waste disposal. Globally, impoverished people have a lower life expectancy and consequently, one-third of all human deaths are related to poverty. The quality of life is also diminished because the poor often cannot afford to rent or own land, and therefore resort to squatting.

Squatter communities, also known as slums or shantytowns, arise when a large group of people live on otherwise unoccupied land that they do not have permission to use. There are approximately one billion squatters worldwide and squatter settlements exist on every inhabited continent on earth. In 2010, Costa Rica had 357 recorded squatter settlements. These groups lack basic infrastructure. Drinking water and electricity must be brought in from an outside source such as nearby rivers and neighboring power lines. Homes are constructed from available materials, such as cardboard and aluminum siding. In addition, collection and treatment of sewage and solid waste is typically lacking, which can lead to unsanitary living conditions and the spread of diseases such hepatitis, cholera, and gastroenteritis.

Sewage, also known as domestic wastewater, comes from sinks, drains, and toilets in inhabited buildings. Sewage can be transported to a central location for treatment or treated on-site. When treatment options are not available, raw sewage is disposed of in water or on land. In Costa Rica, only 25% of the population has access to sewage disposal through public sewage lines, 70% has access to septic tanks, and the remaining 5% of the population does not have access to any form of proper sewage disposal. Typically, squatter communities are a part of the 5% that do not have improved human waste management. Many established wastewater treatment and disposal systems in Costa Rica are not functioning effectively. Consequently, approximately 96.5% of wastewater is released untreated to the environment.

Solid waste management is also a challenge in squatter communities. Residents tend to either burn their garbage or informally dump it, both of which can be hazardous to the environment and public health. Burning garbage releases toxins from the waste into the

surrounding environment. In open dumps, the decomposition of organic matter releases methane, a greenhouse gas, which contributes to global warming and can cause fires. Fires generate smoke, which then adds to air pollution. At these open dumps, the garbage is exposed to rain, which can produce leachate. Leachate is water that becomes contaminated as it runs through open dumps and, if not collected, will then contaminate the surrounding environment. In addition, animals feeding at local dumps may transmit diseases to residents living in the community.

Un Techo Para Mi País (UTPMP) is a non-profit organization working to eradicate extreme poverty by providing transitional housing, improving community infrastructure, and defining social structure in squatter communities. The organization relies heavily on donations and an annual fundraiser. Their strategy is to include the residents in the process through education and the creation of sustainable plans specific to each settlement. UTPMP works throughout Latin America and is headquartered in Chile. The organization became active in Costa Rica in 2006 and established a main office in San José. UTPMP works with families, volunteers, companies, the government, and the media to achieve their mission. There are four fundamental areas in which UTPMP is working: strengthening of housing designs, providing access to drinking water, improving community infrastructure design, and managing waste. By addressing these areas, UTPMP works to identify the needs of the people and find low cost design proposals to coincide with the lack of technical knowledge and money available in squatter communities.

In most communities that UTPMP intervenes in, there is no improved human or solid waste management. UTPMP is unique in involving the community and encouraging residents to work together to improve their own quality of life. The organization is committed to researching the different ways that other societies dispose of their waste and developing programs that are appropriate for the squatters in Costa Rica. UTPMP is working on social inclusion programs to address the unique challenges squatter communities face, eventually leading to structured community roles. By combining technical processes and available resources, UTPMP hopes to establish sustainable waste management systems in each community. The goal of our project was to work with UTPMP to address waste management problems in squatter communities in Costa Rica.

## **CHAPTER 2: LITERATURE REVIEW**

This chapter addresses the primary themes associated with our project in greater depth. We worked with Un Techo Para Mi País to address the need for community waste management in squatter communities in Costa Rica. We first define the unique climatic and geographic conditions in different regions of Costa Rica. We discuss the current waste management practices nationwide. Next, we define squatter communities and the distinct challenges residents face. We evaluate the key problems in these communities regarding the relationship between waste management and health concerns. Finally, we investigate the different options for both human and solid waste management.

### **2.1 Geography of Costa Rica**

Costa Rica is a Central American country located 10 degrees north of the equator. It is bordered by Nicaragua on the north, Panama on the south, the Pacific Ocean to the west, and Caribbean Sea to the east. The territorial area of Costa Rica is 51,100 square kilometers and the population was approximately 4,561,000 in 2010 (INEC, 2010). Costa Rica is a tropical country with a distinctive dry season from December to April and a wet season from May to November. These seasons vary slightly by region within the country. The average rainfall in Costa Rica is about 100 inches per year, and some areas with a higher elevation get as much as 25 feet of rainfall annually (CIA, 2011). The Pacific and Caribbean flat coastal regions are separated by central mountains and volcanoes. Average rainfall for each region in Costa Rica is shown in Figure 1.



**Figure 1: Annual average rainfall in Costa Rica (Costa Rica Guide, 2006)**

Costa Rica’s national policy dictates that access to potable water is a universal right. Potable water is defined as water fit for human consumption. In Costa Rica, 96% of people have access to potable water, compared to 84% in Latin American and only 57% of people worldwide (WHO/UNICEF, 2010). Although the vast majority of Costa Ricans have access to potable water, many are severely lacking in proper waste management practices. We assessed waste management practices in squatter communities in two provinces of Costa Rica: Limón and San José. The province locations are shown in Figure 2.



**Figure 2: Provinces of Costa Rica (Sugar Delta, 2011)**

Limón province is located on the west coast in the Caribbean region of Costa Rica. The province stretches from the Nicaraguan border to the Panamanian border, including the entire Caribbean coast. The population of Limón province is approximately 445,000, with a population density of 50 people per square kilometer (INEC, 2010). Limón receives more rain than any other region in Costa Rica; about 133 inches of water annually. This is because the warm air from the Caribbean Sea cools before it reaches the central mountain range, and because cool air holds less water than warm air, it rains. The dry season in Limón lasts only two weeks in February, which is indicative of the poorly defined seasons in this province. Because of the frequency of precipitation, swampland covers a large area of this region (CIA, 2011). Limón has a long history of banana plantations and many residents work at these plantations (J. Sandí, personal communication, October 28, 2011).

San José is the most populated province in Costa Rica with approximately 1,633,000 people and 330 people per square kilometer of land (INEC, 2010). This region is centrally located in Costa Rica and is one of the two provinces that do not border an ocean. The capital city of Costa Rica, San José, is located within this province. The San José province experiences



the most variety in rainfall and temperature because of the variation in elevation, from 3,280 feet to 6,070 feet above sea level (CIA, 2011).

## **2.2 Waste Management in Costa Rica**

Domestic wastewater is wastewater that comes from any inhabited building, including residences, businesses, and schools. It includes grey water, which results from household activities such as laundry and washing dishes, and black water, which includes human waste. In many developed countries, such as the United States, there are laws against releasing untreated wastewater into the environment because of its negative environmental and health affects (Davis, 2009). Wastewater can be treated on-site, or can be collected and transported to a centralized municipal treatment facility.

The majority of Costa Rican residents have access to improved sanitation. Improved sanitation is defined as access to a facility that provides hygienic separation of excrement from human contact (CDC, 2009; WHO, 2008). This includes piped sewer systems, septic tanks, improved pit latrines, and composting toilets. Unimproved sanitation facilities include pit latrines without a slab or platform, hanging latrines, and bucket latrines, as well as any sanitation system shared between more than one household. The full WHO Sanitation Ladder is provided in Appendix A. In Costa Rica, 95% of the residents have access to improved sanitation. Though this percentage is high, it leaves about 228,000 people without improved sanitation facilities (WHO/UNICEF, 2010).

Despite access to improved sanitation, wastewater disposal in Costa Rica is problematic. The Water and Sewage Institute estimated that only about 50% of septic systems in Costa Rica are functional. In 2008, only 3.5% of the country's sewage was managed by treatment facilities (United States Department of State, 2011). In 2009, the government signed into law a plan to increase the amount of treated wastewater from 3.5% in 2008 to 28% in 2015. The plan includes studies on improved sanitation as well as a governmental commitment to investing in improved treatment technologies (McDonald, 2010).

Solid waste consists of everyday items used and discarded, including organic waste, recyclable material, and non-recyclable material. Organic waste is any biodegradable material waste from plant or animal sources. It includes food waste and waste produced by vegetation, such as lawn clippings. These wastes can be composted to reduce their volume (via

biodegradation) and produce a usable product, such as fertilizer to grow plants. Recyclables include paper, plastic, and glass. These materials can be separated and returned to a facility for processing and reuse. Materials that cannot be composted or recycled may be collected by the municipality for disposal. Landfilling is the most common way to dispose of waste. Modern landfills are closely monitored to minimize negative environmental impacts. In a landfill, waste is compacted then buried (WHO, 1996).

Solid waste management in Costa Rica is a challenge. People in Costa Rica generate an average of 11,000 metric tons of solid waste per day, the majority of which is organic waste. Of this solid waste, 75% is disposed of in landfills, though these landfills are rapidly reaching their maximum capacity. Costa Rican business owners put recycling bins outside of tourist destinations to give a good impression to visitors, however, only 8% of the recyclable materials are actually recycled (Mager, 2006). To address this issue, Costa Rican President Laura Chinchilla signed a new Integral Waste Management Law in 2010. The health ministry now supervises a national recycling program. The law requires municipalities to provide waste collection services and keep the water in public spaces free of trash (Hughes, 2010). However, municipalities often lack the necessary resources or are unwilling to comply with this legislation. It is difficult to ask residents to change their current waste management practices when it requires them to spend additional money with no immediate personal benefit. The government has recently been encouraging municipalities to enforce these policies and hold themselves accountable to the law (Villegas, 2011).

### **2.3 Squatter Communities**

A squatter is an individual who illegally occupies land that he or she does not rent or own. According to UTPMP, a squatter community arises when eight or more families of squatters inhabit the same area and are lacking at least one of the three basic necessities: potable water, electricity, or improved waste disposal. Many squatters begin occupying an area by constructing shelters out of available materials such as tin, scrap wood, and cardboard (Figure 3). Others occupy existing structures such as abandoned buildings. There are several reasons why an individual would decide to squat. For example, families living in cramped quarters or unaffordable homes resort to squatting in order to improve their living conditions. In addition, immigrants sometimes have no other option than to squat in order to find jobs in more developed

cities. Many people who resort to squatting are in a desperate situation. Once a family moves into a squatter community, it is often challenging for subsequent generations to move out, due to lack of education and opportunities (Velazquez, 2008).



**Figure 3: Shelters constructed with available materials in squatter community of Cristo Rey, Costa Rica (Photograph by Aaron Behanzin, 2011)**

As shown in Figure 4, squatters tend to occupy land that is unappealing to other potential landowners to reduce the chance that their presence is contested (Mendelsohn, 1994). Communities are often established on unwanted land such as along riverbanks, under power lines, and along highways. The steep slopes make it difficult to build along riverbanks, so prospective landowners are not willing to pay for the land. Riverbank communities are at high risk for natural disasters such as flooding; however, the squatters see several benefits to this land, including fresh water access. Along the highways, the land is level and better for construction, however this land is also undesirable due to the noise and air pollution near highways. Because of the danger of live wires, the land underneath power lines is unappealing to prospective

landowners, and therefore the squatters fill in the empty space. The power lines are used as markers to indicate the borders of a squatter community (Velazquez, 2008).



**Figure 4: Squatter community of Barrio Nuevo, Costa Rica, located along a riverbank (Photograph by Aaron Behanzin, 2011)**

In Costa Rica, squatting can be a way to inform the government and surrounding communities about the unfavorable conditions in the squatter communities. For this purpose, squatters may choose to dwell in a noticeable location to raise awareness of their desperation and need for assistance. They occupy the land in large groups in order to make themselves more noticeable and to assert their presence on the land. Outside organizations can see their desperation and assist them (Cable, 2007).

The illegal formation of squatter settlements has been occurring in Costa Rica since the nineteen thirties. The squatter communities in Costa Rica range from 20 to 7,000 residents. According to *La Nación*, a Costa Rican newspaper, there were 357 squatter settlements in Costa Rica in February of 2011; of those, 179 of the settlements were located in San José. About 74% of squatter communities in Costa Rica are located on government lands (Ross, 2011). In 1942,

the Office of Colonization and Distribution of State Lands was developed in Costa Rica to control governmental land. This office, a part of the Ministry of Agriculture and Livestock, was responsible for making uninhabited state lands available to squatters. However, this strategy failed to solve the problem. The squatters were not interested in this land because of its seclusion from society. In response, the Institute of Lands and Colonization (known today as the Agrarian Development Institute) executed a plan in 1962 to provide compensation to private owners of squatter occupied land. To begin, they offered the uninhabited state land to owners who lost their land to squatter settlements. Because the uninhabited state lands were usually unappealing, this solution was not accepted by the landowners. In 1969, the Agrarian Development Institute worked to resolve the conflict between the landowners and squatters (Trackman, 1999). Since 1974, 37 new squatter settlements have been established in San José (Velazquez, 2008). Today, Costa Rica has a law that the government must provide alternative land for squatters to live on if they are evicted. Due to this law and the complexity of the legal process, squatter communities are often permitted to exist on government property.

Costa Rica participates in national treaties that guarantee the right to education, healthcare and functional housing to all those who live in the country, regardless of whether they are a taxpaying citizen. Because of this policy, the squatters throughout the country are able to receive free public education, health care, improvements in their communities, and job opportunities (Cable, 2007). However, in many cases, the squatters do not receive these benefits because of the need to work or the distance to these services. The Costa Rican government grants the squatters rights to the land after they reside there for one year. After remaining there for 10 years, they are able to obtain a title for the land (Kovaleski, 1998). There have been organizations that visit squatter communities in order to make education and health care more available to squatters. For example, the Costa Rican Humanitarian Foundation began working in the squatter settlement of La Carpio in 1997 and worked to increase education and health care availability for children by organizing different workshops. They have provided a wide variety of resources including clothing, toothbrushes, and toys, as well as services such as health workshops (Cable, 2007). Although many services are legally available to the squatters by the Costa Rican government, not all squatters are able to utilize these benefits.

While rights to education, healthcare, and other services can be beneficial to squatters, these rights cause tension between the natives and foreign squatters, especially Nicaraguans.

According to a study published by the University of Costa Rica, 75% of the foreign population in Costa Rica is made up of Nicaraguans who come to the country in search of work (Crabb, 2003). Immigrants are often willing to work for less than native Costa Ricans. Approximately 500,000 Nicaraguans work in Costa Rica during the harvest season and at any point in time there are roughly 100,000 illegal Nicaraguans in the country. The largest squatter settlement in Central America is located in Guararí de Heredia, Costa Rica, in which 59% of the residents are of Nicaraguan decent (Swedish Cooperative Center, 2007). In addition, many pregnant illegal immigrants come to Costa Rica to bear their children because of the universal healthcare policy (José Antonio Aroya, personal communication, November 24, 2011). In Costa Rica, the view on foreign squatters is that “their presence taxes the healthcare and education systems” (Crabb, 2003).

## **2.4 Un Techo Para Mi País**

Our sponsor, UTPMP, has developed a three-phase plan to develop a sustainable community from an under-developed settlement. The first phase begins with the large-scale construction of transitional houses. The homes are constructed in cooperation with the family in need with eight to ten UTPMP volunteers over two days. The homes are made from wood and aluminum, are mobile, and are 18 square meters in size (see Figure 5). The cost of the home is \$2,000 USD and the family must contribute 10% of these funds. The home allows families to be protected from cold, infestations, rain, and crime. By providing the families with this improved security, UTPMP establishes the first bonds of trust, which in turn allows them to continue working in these communities.

The second phase is the implementation of social inclusion programs in the communities. The volunteers from UTPMP lead programs in education, healthcare, economic development, microfinance, cultural and recreational education, and vocational training. UTPMP also organizes community meetings where the residents are encouraged to elect leaders. This phase empowers the community residents to actively participate in improving the community as a whole.

The third phase is focused on forming a sustainable community that can govern itself. In this phase, UTPMP helps families develop their own community with social capital. Social capital refers to the social connections between families. UTPMP also emphasizes the

importance of bonds between neighbors and links with external networks. Residents are encouraged to define community problems and determine possible solutions on their own.



**Figure 5: Home built by UTPMP in squatter community of Ramal 7, Costa Rica (Photograph by Aaron Behanzin, 2011)**

Many different organizations, similar to UTPMP, have worked on improving the living conditions in squatter communities. Some organizations have difficulty gaining the trust of the residents. For example, the Programa de Desarrollo Local (PRODEL, *Local Development Program*) worked in squatter communities in Nicaragua. The organization addressed the basic needs related to urban poverty: lack of adequate employment, infrastructure, and shelter. PRODEL financed improvements of these needs through the local governments. PRODEL interviewed members of the communities in which they worked. Interviewees noted that they were hesitant to receive aid from the organization because they did not know PRODEL members and were unknowledgeable about the aid they could be receiving (Heinemann, 2010). To overcome these problems, many organizations have begun focusing on personal relationships with the community members. UTPMP volunteers value these relationships with members of the

communities and the organization incorporates the social inclusion initiative to address root problems of poverty, such as unemployment, violence, and substance abuse. Because UTPMP includes community members in all phases of their program, residents are motivated to continue development independently.

## 2.5 Health Implications

Improper disposal of human waste can contaminate surface water and groundwater systems, which can lead to adverse human health effects if that water is then used by the local community. Lack of proper sanitation and solid waste disposal in squatter communities can lead to the spread of pathogens. Diseases resulting from improper sanitation include cholera and typhoid (WHO/UNICEF, 2010).

Pathogens are microorganisms that infect a host, such as humans and animals, and cause disease. Many waterborne pathogens are transmitted by the fecal-oral route. Fecal-oral pathogens are transmitted via ingestion of food or water contaminated by the feces of an infected host (Stoeckel, 2006). Pathogens can travel in a variety of routes, as illustrated in Figure 6. Lack of proper sanitation allows this cycle to continue. In order to minimize pathogen transmission, untreated human waste must be kept separate from water supplies, human contact, the ground, and flies.

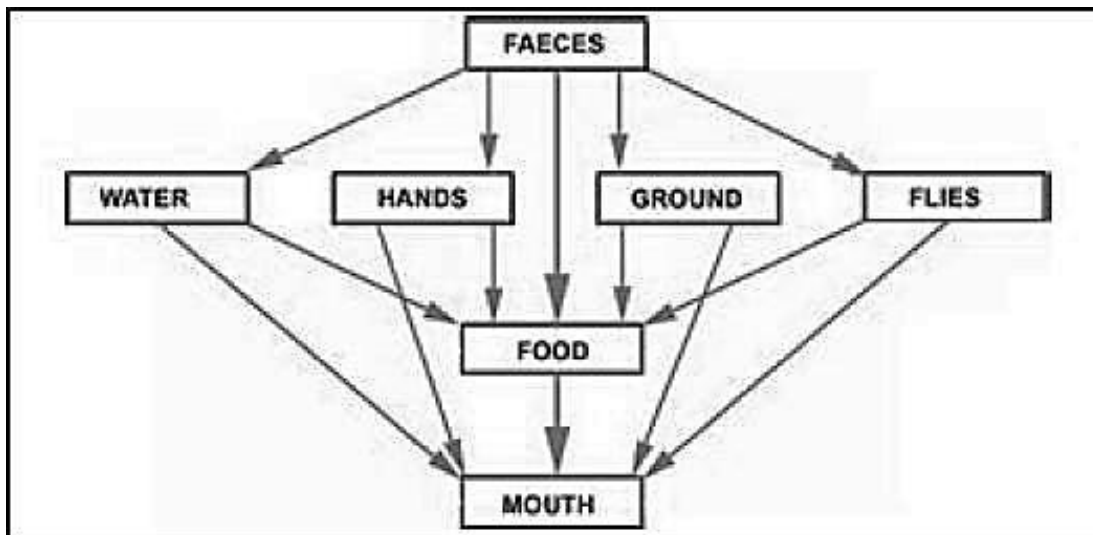

Figure 6: Disease transmission via the fecal-oral route (Huuhtanen, 2006)



Many fecal-oral pathogens cause gastroenteritis, which manifests itself in acute diarrhea. These pathogens include *Shigella* (dysentery), *Vibrio cholera* (cholera), and *Salmonella* (typhoid). The symptoms of these illnesses are different, but all result in diarrhea. Acute diarrhea is defined by the WHO (2011) as the passage of three or more loose or liquid stools per day. Acute diarrhea causes dehydration that can be fatal, especially in children or malnourished people. Diarrheal diseases are both preventable and treatable, but are the second leading causes of death among children under five years old, killing 1.5 million children annually (WHO, 2011). Chronic diarrhea can result in permanent damage to the gastrointestinal tract. Diarrhea is treated by rehydrating the infected individual with water or oral rehydration salts. Treatment can be a challenge for squatter communities that do not have access to safe drinking water or proper health care.

## **2.6 Case Study: Namibia**

The relationship between sanitation and health effects is demonstrated by a case study in farming communities in Namibia (Boutin, 2011). In these communities, residents obtained their drinking water from groundwater through boreholes. The boreholes were contaminated with human waste, which led to chronic health effects including methemoglobinemia and gastrointestinal illnesses. Worcester Polytechnic Institute (WPI) researchers visited these communities and measured fecal bacterial levels in eight wells. They found these bacterial levels to be unsafe in six of the wells. The communities that used these water sources had appointed one resident who acted as the maintenance worker for the boreholes. The organization that manages the water supply of these communities, the Directorate of Water Supply and Sanitation Coordination (DWSSC), trained the maintenance worker; however, the boreholes were occasionally without a maintenance worker due to lapses in education of new workers.

The Desert Research Foundation of Namibia (DRFN) sought recommendations from WPI researchers on how to improve sanitation in the communities and therefore improve drinking water quality. The researchers assessed eight wells by testing water quality and analyzing the water and wastewater infrastructure. The infrastructure was found to be adequate and only in need of minor repairs. The water quality tests showed that fecal contamination was due to both human sanitation behaviors and livestock defecation near water sources.

The researchers went to the rural communities to discuss with the residents the health dangers of contaminated water and what suggestions they had for sanitation. Specifically, the group suggested an Otji-Toilet dry sanitation system, which is illustrated in Figure 7. The Otji-Toilet system was developed by a German named Peter Arndt, in 2002. The toilet separates solids and liquids without the use of water, which is necessary for these communities because of the scarcity of water as a resource. The researchers then coordinated the implementation of this toilet system, complete with recommendations on maintenance of the new system to the DRFN.



**Figure 7: Dry sanitation Otji-Toilet system (Image by Boutin, 2011)**

Community involvement was important in implementing the Otji-Toilet system. The recommendations for the rural communities included relocation of livestock, installation of Otji-Toilet systems, and development of routine water testing. The work in Namibia was a good model to use in the development of a proper waste management system for Costa Rican squatter communities because of a similarity in resources and goals of the projects (Boutin, 2011).

## **CHAPTER 3: METHODOLOGY**

The goal of our project with Un Techo Para Mi País (UTPMP) was to develop a manual for determining feasible waste management solutions for squatter communities in Costa Rica. In the first stage of research, we assessed the current means of waste management in five communities by conducting site assessments and analyzing surveys conducted by UTPMP. In the second stage, we developed a manual for UTPMP and community leaders that details feasible waste management strategies. Finally, we developed recommendations for human and solid waste management systems for two specific communities in Costa Rica. This chapter describes the methods used to evaluate current practices in squatter communities and develop the manual.

### **3.1 Community Assessment**

We assessed the current waste management practices in five communities in Costa Rica: Cristo Rey, Vida Nueva, Ramal 7, Barrio Nuevo, and Guararí. These five communities were selected because of their progress in UTPMP's second phase social inclusion program and strong connection to UTPMP volunteers. We conducted site assessments and obtained information through personal communications and observation on current practices. We cataloged surveys conducted by UTPMP to determine the most prevalent waste management practices in squatter communities and the average income of the residents to determine what they can afford regarding waste management options. We integrated these data with our background research to determine waste management challenges in squatter communities.

#### **3.1.1 Site Assessment**

We conducted site assessments in all five of the communities listed above. UTPMP volunteers who previously worked with each community and had a strong relationship with the residents accompanied us on these visits. We collected information through personal communications with UTPMP volunteers and community leaders. We inquired about the most common waste management practices, the resources available to the community members, and the general attitudes in the community about improving their current waste management practices. We walked through each community for one to four hours and took photographs to document conditions. We observed waste management practices and the conditions of streets and

rivers in the communities. When possible, we viewed homes and public buildings with a member of the community. We also looked for personal gardens to note the possible use of compost in each community.

### **3.1.2 Surveys**

UTPMP conducted two different surveys in each community. The first phase housing application surveys were conducted to determine which families would receive transitional housing. All residents in each community were given the opportunity to complete the survey, whether or not they were interested in transitional housing. The surveys asked questions pertaining to finances, sanitation practices, and water sources. The second survey UTPMP conducted was the second-phase social inclusion survey. This survey inquired specifically about the current practices in each community regarding both solid and human waste management. The first and second phase survey questions are shown in Appendices B through F. The surveys were cataloged using Microsoft Excel and results were compared.

### **3.2 Waste Management Manual**

We created a manual that provides options for waste management strategies in squatter communities, including both human and solid waste. The manual is intended for both UTPMP and the community members to use in determining which solid and human waste management systems would be best suited for a particular community. The parameters considered while creating the manual were initial cost, maintenance cost, ease of implementation, ease of maintenance, necessary water input, required space, pathogen runoff, longevity, capacity and efficiency.

The waste management manual was created by referencing several different documents. The solid waste management section of the manual was developed using documentation from organizations such as the US EPA and Recycle Now. We used the *Resource Conservation* documentation published in 2011 from the US EPA. Based on the constraints that we determined from the site assessments and surveys, we developed a list of feasible solid waste solutions for squatter communities. The human waste management section was developed using *A Guide to Sanitation and Hygiene for Those Working in Developing Countries* (Huuhtanen, 2006) and *How to Select Appropriate Technical Solutions for Sanitation* (Frenoux , 2011). Our sponsor

suggested the document by Huuhtanen published in 2006 because the second phase director and her team had been using this guide to address sanitation concerns prior to our involvement with UTPMP. The document by Frenoux published in 2011 contains similar information regarding sanitation services and was used to obtain additional information on options.

The information about implementation presented in the manual was obtained from the WHO Sanitation Fact Sheets (1996). The prices for each system were determined by calculating the total required materials based on WHO sanitation documents and then quoting material prices at EPA, a home improvement center located in Curridabat, San José, Costa Rica. The prices listed are in 2011 USD in the English version of the manual and 2011 CRC in the Spanish version of the manual. The December 13, 2011 exchange rate was used to convert prices (\$1 USD to ₡502 CRC).

### **3.3 Waste Management Recommendations**

We developed recommendations for waste management in two squatter communities. UTPMP chose two communities based on the community progress in the following areas: connections between residents and volunteers, probability of sustaining an improved waste management plan, and the community motivation to improve living conditions.

For human waste, we first developed criteria for evaluating the various waste management strategies in squatter communities. The criteria were cost, land requirements, efficiency, pathogen runoff, and ease of maintenance. We determined the maximum allowable cost for waste management based on the average monthly net income per household calculated from the survey data, although we did take into consideration that they may not be willing to use their total net income on a waste management solution. Next, we sought to minimize the amount of land required by the solutions because the communities are illegal. Efficiency was based on hygienic considerations of minimizing odors and flies. For pathogen runoff, reduction of environmental discharge of pathogens was evaluated. Lastly, strategies that had low maintenance requirements were valued.

Using these criteria, we developed a numerical evaluation matrix to identify the most feasible human waste alternative solutions for the two communities. Each criterion was ranked on a scale from 0 to 100, with 0 being the least desirable option and 100 being the ideal option.

The scores were added for each option and recommendations were presented for black water and grey water management.

For solid waste management, we identified a number of alternatives; however, each alternative was specific to different types of solid waste. For example, composting is only suitable for organic waste, while recycling is only used for items that can be reused. As a consequence, a criteria matrix was not suitable to compare strategies that were for the management of different types of solid waste. Therefore, we focused on cost and land requirements when evaluating solid waste management strategies as these criteria were found to vary significantly among options. We also considered that communities may need to use multiple strategies in combination for management of the different solid waste components.

## **CHAPTER 4: RESULTS AND DISCUSSION**

Our project goal was to determine what waste management practices are most appropriate for residents in squatter communities. Through our research, we determined what the current waste management practices are in five squatter communities in Costa Rica. This chapter presents the results of the site assessments we conducted and the surveys that UTPMP administered in five squatter communities, four urban and one rural. We used these data to determine current practices and understand what constraints concerning waste management are present in each community. After comparing the current waste management practices in the communities, we created a manual that presents feasible solutions for the management solid and human waste.

### **4.1 Current Community Practices**

We conducted site assessments in four urban communities in San José province (Cristo Rey, Vida Nueva, Barrio Nuevo, and Guararí) and one rural community in Limón province (Ramal 7). Communities are classified as urban or rural by their proximity to a city. The locations of these squatter communities are shown in Figure 8. We evaluated the current solid and human waste management practices in each community. In order to determine if there is a possibility for use of compost in each community, we looked for personal gardens and farms.



**Figure 8: Location of squatter communities (Adapted from Into Costa Rica, 2009)**

Two different surveys from UTPMP were assessed: initial housing surveys and social inclusion phase surveys (see Table 1). The initial housing surveys are used during the first phase of UTPMP's community development plan to determine who is eligible for housing and focus on the finances and the quality of the home in which the residents live. Information regarding human sanitation services and water sources is included in this survey. The social inclusion surveys contain detailed information regarding sanitary services and solid waste management. They are conducted in the second phase of UTPMP's community development plan. Both surveys were conducted in Vida Nueva, Cristo Rey, Guararí, and Ramal 7, while only the initial housing survey was conducted in Barrio Nuevo. There is one survey per household for any family that wishes to participate in both the initial housing surveys and the social inclusion surveys. The first phase surveys are only for families that wish to apply for housing and the second phase surveys are for the entire community. Consequently, a greater percentage of households in each evaluated community responded to the second phase surveys and the data are more representative of the community as a whole. Because the surveys are revised frequently, the age of the surveys determines the extent of information that is included. The first phase surveys conducted by UTPMP in Cristo Rey, Vida Nueva, Ramal 7, and Barrio Nuevo were conducted in 2010. The first phase surveys for Guararí were conducted in 2009 and did not



include information about waste management practices. Regardless of year, first phase surveys provide data about income per capita, average number of residents per household, and potable water access. The second phase surveys provide data on sanitary services, potable water sources, garbage collection, and average monthly spending. We were able to calculate the approximate number of households in each community by dividing the approximate community population by the average number of people per household based on first and second phase survey results. The population data of each community was received from personal communication with our sponsor and community members. Because each completed survey represented one household's waste practices, we were able to calculate the percentage of households that responded to the surveys by dividing the number of households that responded by the approximate number of households in the community (see Table 1).

**Table 1: Surveys conducted by UTPMP**

<b>Community</b>	<b>Survey Phase</b>	<b>Year</b>	<b>Approximate Number of Households*</b>	<b>Number of Households Responded</b>	<b>Percentage of Households Responding</b>
Cristo Rey	1	2010	54	6	11
	2	2010	50	31	62
Vida Nueva	1	2010	49	13	27
	2	2010	49	47	96
Ramal 7	1	2010	89	24	27
	2	2011	125	67	54
Barrio Nuevo	1	2010	184	72	39
Guararí	1	2009	1224	23	1.9
	2	2010	1363	83	6.1

\* Calculated by dividing community population by average number of persons per household

#### **4.1.1 Cristo Rey**

There are approximately 200 residents in Cristo Rey with an average of 3.7 (second phase surveys) to four (first phase surveys) residents per household. First phase survey results show that the average monthly income per capita in this community is \$113 USD and second phase surveys show that the income is \$104 USD. Through our site assessment, we viewed community water sources, which consist of a communal tap and illegal taps from a main national water line. The surveys corroborate these observations: 67% of the households surveyed use the

communal tap as their water source and 33% tap the national line illegally. The surveys also indicate that 83% of the households in this community use a pipe for sanitation and 17% use unlined pit latrines. The residents told us that these pipes empty directly into the river. With regard to solid waste, we viewed burnt remains of garbage during our site assessment, as shown in Figure 9. Through personal communication with a UTPMP volunteer, we found that there is no municipal trash collection service available to these residents, and therefore they resort to informally dumping and burning their solid waste. During our site assessment, we viewed one small personal garden where compost could be used.



**Figure 9: Solid waste burning in Cristo Rey (Photograph by Aaron Behanzin, 2011)**

#### **4.1.2 Vida Nueva**

Vida Nueva has approximately 200 residents with 4.1 people per household on average, according to both surveys. Vida Nueva is located in the Tres Ríos municipality. According to the first phase surveys, the average monthly income per capita in this community is \$72 USD, and according to the second phase surveys it is \$152 USD. This discrepancy is due to the different sample size and participant pool between the two surveys. As mentioned previously, the first phase survey results are representative of the residents who wish to apply for housing, while the second phase survey results are more representative of the community as a whole.

Through personal communication with UTPMP volunteers, we determined that organic waste is composted by few families in this community. However, through personal

communication with the community leader, we learned that composting is not a community wide practice. During our site assessment, we saw one home that has a small personal garden. Because the community is on illegal land, the residents do not pay the municipality for their garbage collection services, and therefore they must transport their waste to legal properties at the entrance of the community to be collected. The community is located between two steep hills that have a river at the bottom. The main entrance to the community is at the top of one of the hills, which deters some residents from transporting their waste to the collection location, resulting in an open dump in the community. The children in this community are interested in recycling and they separate the recyclables from the remaining solid waste to be ultimately collected by the municipality. UTPMP volunteers believe that when the recyclables are collected by the municipality, they are ultimately combined in a landfill with all other solid waste and are not recycled. The efforts of the children are indicative of the motivation of the younger generation to improve their waste management practices. According to the Municipality of Tres Ríos, trash collection service costs ₡2,500 CRC (\$5 USD) per household every month to receive the service twice per week. This service is provided to all residents of the Tres Ríos municipality if they pay, whether they are tax-paying citizens or not.

From the initial housing surveys conducted in Vida Nueva, we determined that 83% of the households get their water from a communal tap and 17% acquire water from a natural source, such as the river. We also determined that 41% use a pipe that leads into the river and 42% use an unlined pit latrine to dispose of their human waste. The remaining 17% do not have any method of disposal, which refers to open urination and defecation.

#### **4.1.3 Ramal 7**

Ramal 7 is home to 500 residents and there is an average of 4 to 5.6 people per household, according to the second phase surveys and first phase surveys respectively. Ramal 7 is located in the municipality of Matina. The houses in Ramal 7 are not constructed as closely together as the houses in the urban communities we visited. Through personal communication with a community member, we determined that the residents of the community are largely employed by nearby banana plantations. The first phase surveys showed that the monthly average income is \$69 USD per capita and the second phase surveys indicated that it is \$179 USD. This large gap in income can be attributed to the different survey respondents for each

survey. Through the site assessment, we viewed the community school, where children have a small garden. We also visited a resident's home, where the family has a small herb garden. Through personal communication with this resident, we learned that this is not a common practice among the residents.

A UTPMP volunteer stated that wastewater from the households is transported by a series of canals that empty into a river. During our site assessments, we viewed these canals. Each household is required to maintain the canal in front of their property so it properly drains wastewater. Through personal communication with a resident, we determined that the community floods approximately four times annually. There are typically three small floods, in which floodwaters are less than 1.5 meters in height, and one large one, which is greater than 1.5 meters. The flood categories are based on the housing construction in the community: a large flood is when the water reaches the floor level of the raised houses, which are 1.5 meters off of the ground. These floods generally occur during the rainy season, which peaks in Limón during December. These floods disperse the wastewater from pit latrines and canals into the roads and the residents' homes. With regard to flooding, residents of the community have expressed concerns regarding a nearby dam. We did not view the dam during our site assessment, therefore, the following information was provided through personal communication with a resident. The dam is believed to reduce the flooding in the plantations; however, residents state that the dam prevents the floodwaters from draining out of the community. The residents have also expressed concerns that water running from plantations into the community could be contaminated by pesticides, resulting in health hazards in the community.

There are different solid waste disposal methods present in Ramal 7. The residents bring their recyclable materials to the community school, where it is collected by the municipality. The remainder of the solid waste is informally burned or disposed of in open spaces, as shown in Figure 10. A collection truck comes irregularly to collect solid waste from the rest of the community. The last time the truck came was three months prior to our visit. Information regarding the history of municipal collection was not available. Phone calls made to the municipality of Matina regarding price of collection services were not returned.



**Figure 10: Solid waste accumulation in Ramal 7 (Photograph by Aaron Behanzin, 2011)**

The residents of Ramal 7 have access to two communal taps and many have private wells as their water source. From the first phase surveys, we determined that 8% of the households rely solely on a communal tap, 21% of the households rely on a private well only, while 13% has their own pipe. The remaining 58% use a combination of the communal tap and a private well. A UTPMP volunteer stated that the residents use water from the communal tap for drinking and the private well for daily household activities, such as washing dishes and bathing. As mentioned previously, the residents of the community have expressed concerns regarding possible pesticides in the private well water. They are also concerned about possible contamination from the nearby latrines. A private well, as shown in Figure 11, is a pit that we estimated to be four feet deep. The shallowness of the wells may be attributed to the high groundwater table. Groundwater is pumped manually or electrically from this pit into a storage container. The container has pipes that lead directly into the house to the sink and shower. One of the wells that we viewed during our site assessment is located approximately 10 feet away from a pit latrine, while another well that we saw is located inside a home. Through our research on WHO standards, latrines should be at least 30 meters from water sources to prevent contamination. Through personal communication with a UTPMP volunteer, we determined that the private wells do not provide water during the dry season.



**Figure 11: Private well in Ramal 7 (Photograph by Aaron Behanzin, 2011)**

The surveys indicated that the residents often use one unlined pit latrine per household to collect and dispose of their human waste. Specifically, 59% of households use an unlined pit latrine, 18% have a pipe that leads from their home, and 23% have no method of disposal (open urination and defecation). Only 8% of the households in Ramal 7 have no access to potable water. For their garbage collection service, 60% pay for municipal collection, which is irregular, while 35% illegally obtain collection services without paying. The remaining 5% of the households informally burn their trash. These results are contradictory to what we viewed during our site assessment. As we walked throughout the community, there were ashes from burnt trash along the sides of the roads and we observed several families burning their trash during the time of our visit. For this reason, we believe the percentage of households that burn their solid waste is higher than reported.

#### **4.1.4 Barrio Nuevo**

There are approximately 900 residents in Barrio Nuevo and as indicated by UTPMP's first phase surveys, there is an average of 4.9 people per household. The average income per capita of these residents is \$94 USD per month, according to the first phase surveys. There were

no second phase surveys conducted in Barrio Nuevo. Through personal communication with UTPMP volunteers and a community resident, we determined that the residents of this community have a solid waste collection service available; however, many community members do not utilize this service. The community is divided into two sectors and the municipal collection location is on the top of the hill where the second sector of the community is located. The municipality only collects trash that is placed in bags. Some residents cannot afford to purchase the bags and in other cases, dogs in the community go to the location and chew through the bags. This results in solid waste littering the collection site. Because the collection location is on the top of the hill, many residents in the bottom sector of the community do not bring their trash there and resort to disposing of their trash in the river and on the side of the street, which we viewed during the site assessment. An open dump on the side of the street in the bottom sector of the community is shown in Figure 12. With regard to drinking water, survey results showed that 79% of the households in this community have their own pipes to direct potable water into their homes, while 20% rely on a communal tap. Only 1% of households do not have access to potable water.



**Figure 12: Open dump in Barrio Nuevo (Photograph by Aaron Behanzin, 2011)**

Through personal communication with a community member, we determined that when the community of Barrio Nuevo was first established, the residents developed a plan to direct all black water and grey water from the homes in the first sector through pipes into the river. As the

community expanded and other homes were constructed further from the river in the second sector, new homes were not included in the wastewater disposal plan. Therefore, these residents dispose of their human waste via pipes that lead directly onto the street.

#### **4.1.5 Guararí**

Guararí was the largest community we visited in Costa Rica, with approximately 6,000 residents. In comparison, this community has over 6 times as many residents as the second largest community we observed, Barrio Nuevo. The first phase surveys indicate that each resident earns about \$31 USD per month and the second phase surveys indicate that the income per capita is \$109 USD per household. Again, this discrepancy in reported income is due to the different sample sizes and respondents of the surveys. On average in this community, four or five families live in each home (Community resident, personal communication, November 29, 2011). The first phase surveys reveal that the average number of residents per household is 4.9 and the second phase surveys indicate 4.4 people per household.

Some residents of Guararí own the land on which they live, and the municipality provides a solid waste collection service that costs each family \$34 USD a year. Since this service is not available to the illegal residents of the community, they commonly resort to disposing of their solid waste in the river. The solid waste accumulates and periodically creates a dam that blocks the river from flowing. When this occurs, the community plans activities to manually clean up the river. They discuss the event with the municipality so services can be arranged to collect the trash that is removed. The municipality collects this trash without any payment because the blocked dam affects tax paying residents. This cycle repeats because the community members do not have an alternative waste disposal option and they continue disposing of their trash in the river (Community resident, personal communication, November 29, 2011). This river is shown in Figure 13. There is a part of the river that is too narrow to access and the buildup of solid waste there cannot be cleared. Second phase surveys indicate that 0% of the residents dispose of their garbage in the river. However, through our site assessment and personal communication with a community member, we determined that residents do dispose of their solid waste in the river. During our site assessment, we viewed residents throwing their trash through a window into the river.





**Figure 13: River running through Guararí (Photograph by Aaron Behanzin, 2011)**

Through the second phase surveys, we determined that 38% of the households use a toilet for their sanitary service. This refers to the bathroom fixture and is not to be confused with a flush toilet. Thirty-one percent of the households use unlined pit latrines. Twenty-six percent have a septic tank to dispose of their human waste and the remaining 5% have no method of disposal and therefore resort to open urination and defecation. Ninety-two percent of the households in this community rely on a stream as their water source. The remaining 8% of households responded other.

In 2009, the government revoked the rights of the residents of Guararí to make any structural changes to their homes. The goal of this act was to encourage the squatters to move out of the community gradually, without the government having to complete the intensive legal eviction process. It is therefore illegal to construct houses or implement a waste management system in Guararí (UTPMP volunteer, personal communication, November 29, 2011).

## **4.2 Community Waste Comparison**

We compared the similarities and differences in the communities to determine the limiting factors present in squatter communities with regard to waste management. We compared the number of residents in each community, current solid and human waste management

practices, and water sources as shown in Table 2. “Latrine” in this table refers to an unlined pit latrine that deposits waste into the ground. “Pipe” in this table refers to a pipe that goes from the house directly into the river. We inquired with our sponsor about information regarding area and population density, but this information was unavailable.

**Table 2: Common waste management practices**

Community	Number of Residents	Solid Waste Management Strategies	Human Waste Management Strategies	Water Source
Cristo Rey	200	<ul style="list-style-type: none"> <li>• Burn</li> <li>• River</li> </ul>	<ul style="list-style-type: none"> <li>• River</li> </ul>	<ul style="list-style-type: none"> <li>• Illegal tap</li> <li>• Communal tap</li> </ul>
Vida Nueva	200	<ul style="list-style-type: none"> <li>• Compost</li> <li>• Weekly municipal collection</li> </ul>	<ul style="list-style-type: none"> <li>• Latrines</li> <li>• River</li> </ul>	<ul style="list-style-type: none"> <li>• Illegal tap</li> </ul>
Ramal 7	500	<ul style="list-style-type: none"> <li>• Burn</li> <li>• Recycle</li> <li>• Quarterly municipal collection</li> </ul>	<ul style="list-style-type: none"> <li>• Latrines</li> </ul>	<ul style="list-style-type: none"> <li>• Private well</li> <li>• Communal tap</li> </ul>
Barrio Nuevo	900	<ul style="list-style-type: none"> <li>• Open dump</li> <li>• Biweekly municipal collection</li> </ul>	<ul style="list-style-type: none"> <li>• River</li> </ul>	<ul style="list-style-type: none"> <li>• Illegal tap</li> </ul>
Guararí	6,000	<ul style="list-style-type: none"> <li>• River</li> </ul>	<ul style="list-style-type: none"> <li>• River</li> </ul>	<ul style="list-style-type: none"> <li>• Illegal tap</li> </ul>

Analysis of site assessments and surveys revealed common practices in the communities. For solid waste management, common practices are burning trash, open dumping, and irregular municipal collection. For human waste, four of the five communities dump their wastewater into local rivers. In Figure 14, the sanitation services for each community are compared. The data shown in this figure was collected from the first phase surveys that inquired about sanitation services. The responses for the questions were pipe, latrine, or none available. The response “none available” refers to open defecation (J. Sandí, personal communication, November 22, 2011). Guararí is not included in this graph because the first phase survey for that community did not inquire about sanitation services. In addition, four of the five communities’ main water source is illegally tapping out of a national company water line.

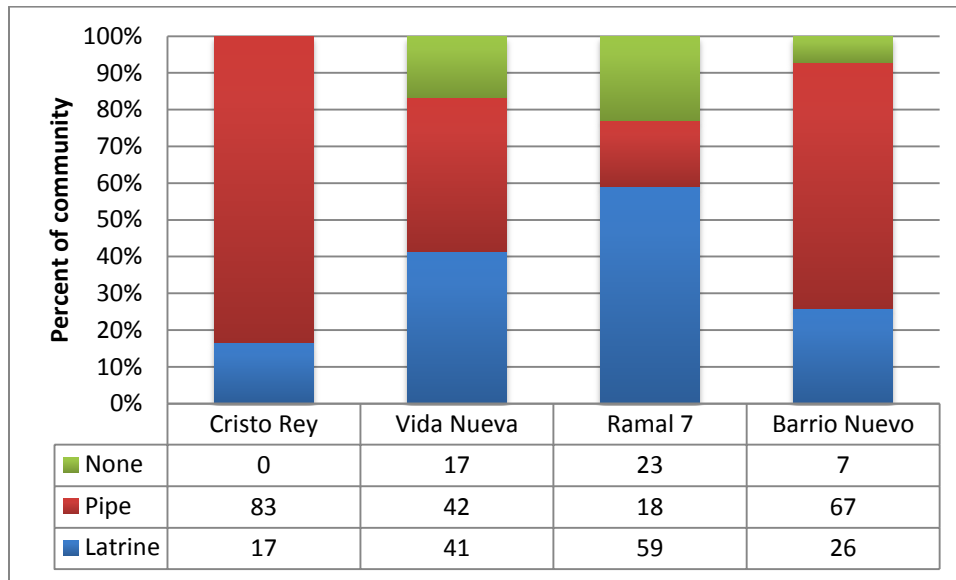

**Figure 14: Sanitation services in squatter communities**

According to the WHO and UNICEF Joint Monitoring Programme for Water Supply and Sanitation standards, all of the communities we saw have unimproved sanitation. Unimproved sanitation is described as a facility that does not ensure the separation of human excreta from human contact, which includes an unlined pit latrine without a platform (WHO/UNICEF, 2010).

Financial information in each community was also compared. First, gross household income was calculated based on the second phase surveys. Income per capita reported by the surveys was multiplied by the average number of residents per household as reported by the second phase surveys. Household expenditures were calculated by multiplying the reported number of residents per household by the average monthly expenditures per capita, also reported by the second phase surveys.

Net household income values were calculated by subtracting reported monthly household expenditures from gross household income values, collected from second phase surveys. This data is presented in Table 3. As previously stated, the data collected from the second phase surveys is more indicative of the community as a whole. Second phase surveys were not conducted in Barrio Nuevo and therefore those data are omitted from the table. Gross household expenditure data were not included in the second phase surveys conducted in Guararí and therefore those data are unavailable. We used the net household income values to determine what

waste management solutions would be affordable. The results from our calculations are shown in Table 3.

**Table 3: Household monthly financial information from second phase surveys**

Community	Monthly Financial Information (USD)				
	Gross Income		Expenditures		Net Income
	Per Capita	Per Household	Per capita	Per Household	Per Household
<b>Cristo Rey</b>	\$104	\$385	\$96	\$355	<b>\$30</b>
<b>Vida Nueva</b>	\$152	\$623	\$92	\$377	<b>\$246</b>
<b>Ramal 7</b>	\$179	\$716	\$110	\$440	<b>\$276</b>
<b>Barrio Nuevo</b>	N/A	N/A	N/A	N/A	N/A
<b>Guararí</b>	\$109	\$480	N/A	N/A	N/A

### 4.3 Developing Feasible Waste Management Solutions

We addressed the goal of determining proper waste management solutions by providing UTPMP and squatters with the information on how to improve their sanitation practices. We provided a manual to UTPMP and community leaders with a compendium of feasible waste management solutions. It allows the community members to make an educated decision as to which improved waste management plan is appropriate for them. The manual is prefaced with a table that allows the user to determine visually what solution may be appropriate for the community conditions. We included specific information on how to construct each solution, how much the plan costs, and how to maintain the system.

The parameters considered while creating the manual were initial cost, maintenance cost, ease of implementation, ease of maintenance, necessary water input, required space, pathogen runoff, longevity, capacity, and efficiency. We also considered that the communities are illegal, and therefore the residents can be reluctant to implement strategies with expensive permanent structures. Community members can be forced to leave the land if the government chooses to pursue the extensive eviction process. Residents may not be willing to pay upfront for a solution when it's not guaranteed that they will see the long-term benefit if they are evicted. These families also have limited income to spend on waste management solutions. Nevertheless, it is

important to provide information to these residents so they can, if they choose, implement an improved waste management system. The manual can be found in Appendix G.

#### **4.3.1 Solid Waste Manual**

We developed a solid waste manual for UTPMP to use as a tool to propose solutions to squatter communities. Through our research, we developed a preliminary list of solid waste solutions: composting, recycling, receiving municipal trash collection, incinerating, landfilling, and using a refuse pit. From this list, we selected strategies with low cost, minimal land requirement, and simple implementation. Because during the second phase community residents are becoming self-sufficient, we also selected systems that could be easily constructed, used, and maintained. Constructing a sanitary landfill in a squatter community is not feasible because it has a high cost for implementation. Landfills also require a significant amount of land that is not available in these communities. The machinery necessary to construct a sanitary landfill or an incineration facility is not available to residents of squatter communities. Therefore, incineration and sanitary landfills were eliminated as options. Through personal communication with a UTPMP volunteer, we determined that in Costa Rica, recyclables can be sold to a local collection center for a small profit. We also determined that there is a compost market. Information regarding the average selling price of both recyclables and compost was not available. The solid waste disposal methods included in the manual are listed in Table 4 with what types of waste the methods can be used for, advantages, and disadvantages of each option. The manual is provided in Appendix G.

**Table 4: Summary of solid waste management options**

<b>Management Option</b>	<b>Types of Solid Waste</b>	<b>Advantages</b>	<b>Disadvantages</b>
<b>Recycle</b>	<ul style="list-style-type: none"> <li>• Glass</li> <li>• Plastic</li> <li>• Cardboard</li> <li>• Aluminum</li> <li>• Paper</li> </ul>	<ul style="list-style-type: none"> <li>• Profitable</li> <li>• Saves natural resources</li> <li>• Saves space in landfills</li> </ul>	<ul style="list-style-type: none"> <li>• Requires time</li> <li>• Requires transport to local center</li> </ul>
<b>Compost</b>	<ul style="list-style-type: none"> <li>• Yard waste</li> <li>• Napkins &amp; paper towels</li> <li>• Shredded newspapers</li> <li>• Manure</li> <li>• Food waste (fruits, vegetables, rice, beans, egg shells)</li> <li>• Food boxes (shredded)</li> <li>• Urine</li> </ul>	<ul style="list-style-type: none"> <li>• Profitable</li> <li>• Environmentally friendly</li> <li>• Useful to fertilize own crops</li> </ul>	<ul style="list-style-type: none"> <li>• Requires maintenance</li> <li>• Requires space</li> </ul>
<b>Municipal Collection</b>	<ul style="list-style-type: none"> <li>• All types of waste</li> </ul>	<ul style="list-style-type: none"> <li>• All waste is collected and treated elsewhere</li> </ul>	<ul style="list-style-type: none"> <li>• Expensive (continuous cost)</li> <li>• Recyclable &amp; compostable material is mixed with trash</li> </ul>
<b>Refuse Pit</b>	<ul style="list-style-type: none"> <li>• All non-recyclable materials</li> </ul>	<ul style="list-style-type: none"> <li>• Compacts waste</li> <li>• No operating cost</li> </ul>	<ul style="list-style-type: none"> <li>• Requires a lot of space</li> <li>• Risk of health hazards</li> </ul>

Recycling is a process that converts materials such as glass, plastic, cardboard, aluminum, and paper into reusable materials. This process also reduces the volume of waste for other methods of disposal. Recycling is performed by separating all recyclable materials and transporting them to a local collection center, where they are returned in exchange for money (US EPA, 2011b). Collection centers can be found in municipalities across Costa Rica. From the recycling centers, materials are transported to San José and processed to form new materials and products. Recycling saves space in landfills, reduces the use of new raw materials, and can be profitable.

Composting reuses organic materials and reduces the amount of trash for disposal. In a composting bin, organic materials decompose to form a rich soil that can be used in gardens or

sold for profit. Compost is made out of two different categories of materials; brown materials and green materials. Brown materials provide carbon to the compost and include paper, cardboard, leaves, twigs, and soil. The green materials provide nitrogen to the compost and include grass clippings, coffee grounds, and vegetable and fruit peels. The process of composting is shown in Figure 15. Materials like metals, dairy products, and meat products cannot be composted because they do not decompose readily and can attract animals to a composting bin. Composting can be performed in many different bin sizes and materials. A composting bin can be made of plastic or wood and should be closed-topped and stored in a dry, shady spot. Composting can be completed at two different speeds, fast and slow. Fast composting takes 6-8 weeks and can only be completed in a full container. Water is added as the container is filled. Compost gets warm because of the chemicals released during decomposition. When the compost cools, it is turned to reheat and continue decomposing. When the compost no longer heats up, it is left undisturbed to finish composting. Slow compost takes up to a year to fully compost but only requires 30 centimeters of compost to begin decomposing. Small twigs must line the bottom of the container. In slow compost, the fully composted layers can be removed from the bin for use in a garden or sale (US EPA, 2011a).

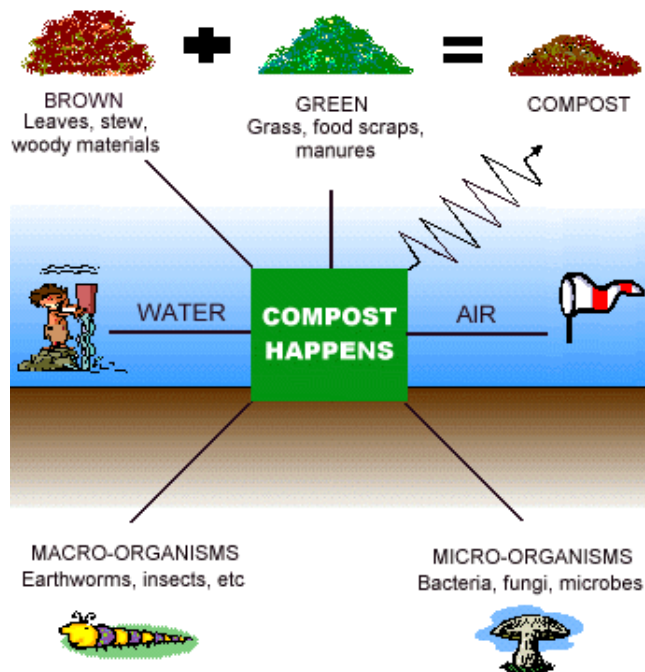

Figure 15: Composting cycle (Torfaen County Borough Council, 2010)

Municipal collection is beneficial for materials that cannot be composted or recycled. Every municipality in Costa Rica offers this collection for a fee that varies by municipality. Once this service is purchased, the municipality collects garbage left outside in bags at specified intervals. Once the waste is collected, it is transported by professionals to a sanitary landfill (J. Sandí, personal communication, November 29, 2011).

A refuse pit is a hole dug into the ground to dispose of non-recyclable materials. A refuse pit is built above groundwater level to eliminate hazardous waste from contaminating water sources. To avoid contamination of any source, refuse pits should be located at least 20 meters away from any kitchen area, 30 meters away from any water source, and not above any pipe that empties into surface water. The pit should have a sealed base with an impermeable material to prevent it from contaminating ground water. Once material is placed into the pit, it should be compacted in order to maximize the quantity of material that can be placed in the pit. When the pit is full, it is typically covered and a new refuse pit dug. This waste remains in the pit indefinitely (WHO, 1996).

#### **4.3.2 Human Waste Manual**

We developed a human waste manual for the squatter communities and UTPMP to implement a solution, taking into consideration what we noted above. Information on options was collected from the following four sources: the *Compendium of Sanitation Systems and Technologies* (Lüthi et al., 2008); sanitation fact sheets published by the US EPA (1998-2011); *A Guide to Sanitation and Hygiene* (Global Dry Toilet Club of Finland, 2006); and *How to Select Appropriate Technical Solutions* (Frenoux, 2011). Feasible solutions were chosen primarily based on cost and ease of implementation. We excluded conventional sewerage because it requires significant investment in engineered treatment processes. Further information regarding these options is located in this chapter and in the manual in Appendix G.

Human waste management options included latrines and other engineered or natural treatment systems. The different latrine options are shown in Table 5. Latrines only apply to the management of black water. The additional treatment systems (for black and/or grey water) are discussed later in this chapter.



**Table 5: Latrine human waste management options**

<b>Latrine type</b>	<b>Advantages</b>	<b>Disadvantages</b>
<b>Pit latrine</b>	Low costs, easy to build, readily available materials, small area of land required	Prevalent flies and odors, major pathogen runoff, cannot be implemented in an area prone to flooding
<b>Ventilated improved pit latrine</b>	Low costs, reduction in flies and odors compared to pit latrines, small area of land required	Major pathogen runoff, cannot be implemented in an area prone to flooding
<b>Pour-flush latrine</b>	Low costs, no flies or odors, small area of land required	Requires constant source of water, major pathogen runoff
<b>Composting latrine</b>	Low operating cost, fertilizer byproduct, can be used in area with high groundwater table, minor pathogen runoff	Medium to high initial cost, required manual removal of waste, requires input of dry litter
<b>Composting latrine with urine separation</b>	Same as composting toilet, requires less litter than composting toilet because urine is separate	Same as composting toilet but more difficult to use

A pit latrine consists of a large hole dug into the ground, covered by a hygienic slab or floor. This slab has a hole, through which human waste can pass into the pit, and a shelter that provides privacy for the user. It is the most basic type of improved sanitation according to the WHO. It can be upgraded to improve hygiene and minimize potential health risks by adding a ventilation pipe. This modification results in a ventilated improved pit latrine, which reduces or eliminates odor problems and flies breeding in the pit. A pit latrine is shown in Figure 16 and a ventilated improved pit latrine is shown in Figure 17. Other alternative designs include multiple pits in order to increase the longevity of the system. All types of pit latrines need to be properly maintained to ensure that there is no risk of disease transmission (WHO, 1996).

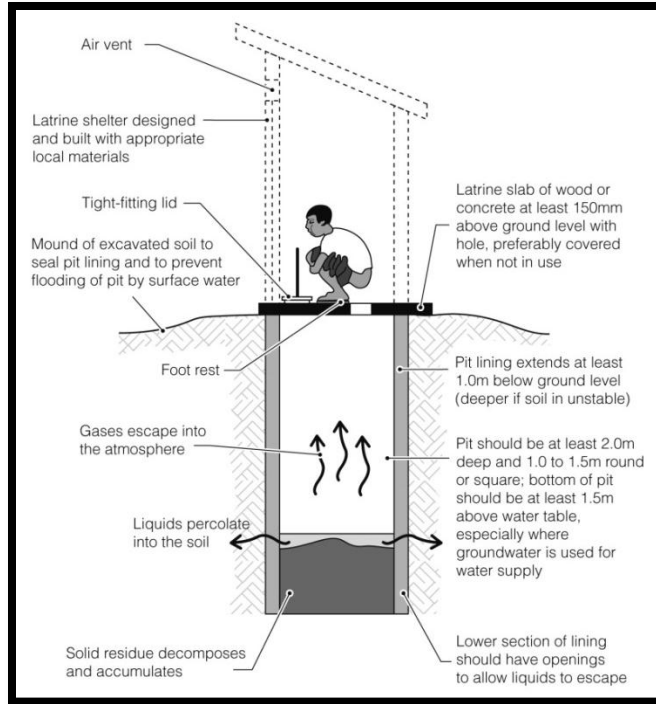

Figure 16: Simple pit latrine (Image courtesy of WEDC ©Ken Chatterton, 2002)

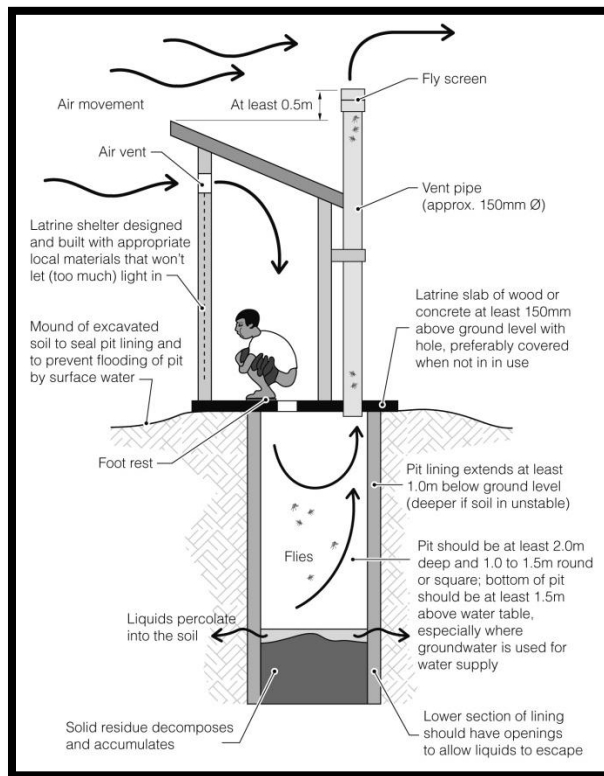
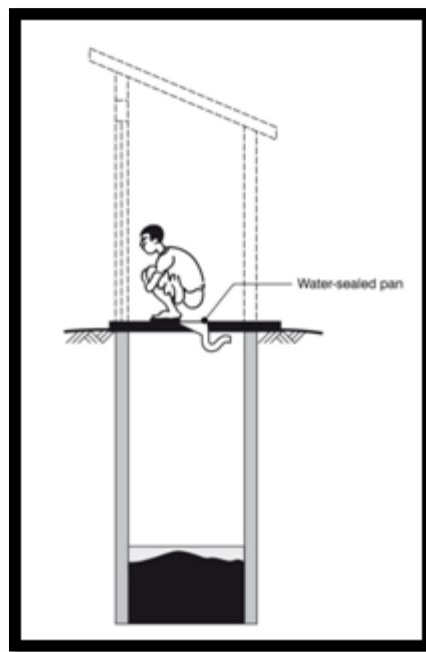

Figure 17: Ventilated improved pit latrine (Image courtesy of WEDC ©Ken Chatterton, 2002)

Another basic type of improved sanitation is a pour flush latrine, shown in Figure 18. It is a simple pit latrine with the addition of a water pan in the slab or floor and an inspection hole with a cover. The water pan eliminates the presence of odors inside the shelter. A pour flush latrine requires about two to three liters of water for flushing each time it is used. An inspection hole can be used to determine when the pit is full, although it may not be necessary as long as there is a way to monitor the level of excreta in the pit. Pour flush and ventilated improved pit latrines are both more hygienic than simple pit latrines. Efficiency and lifespan can be increased using alternative designs, such as a combination of a pour flush and ventilated improved pit latrine (WHO, 1996).



**Figure 18: Flush latrine (Image courtesy of WEDC. ©Rod Shaw, 2002)**

A composting latrine is a dry toilet that operates without water. It is best suited for areas that have limited amounts of water or where the water table is far from the ground surface. There are many alternative designs for a composting latrine, such as a single vault or multiple vaults. It usually consists of two vaults and only one is used at a time. When the first vault is full, it is covered for at least two years and the second vault is used. While the second is in use, the

excreta in the first hole decompose and the pathogens die. Organic waste should be added to help the excreta break down. After each use of the composting latrine, dry litter such as ash or sawdust is added to help reduce odors and absorb the water content of the excreta. The compost from the first vault can be used as a fertilizer and a soil conditioner. There is no need to build a new composting latrine because the compost is removed. A composting latrine is more expensive and more difficult to build compared to a pit latrine or a pour flush latrine, but can be built as a permanent structure (WHO, 1996). Composting latrines can be upgraded to a composting latrine with urine separation. The benefit of a urine diverted composting latrine is that it reduces the amount of leachate production, which also means that there is less need to add litter to absorb the water. Composting latrines require maintenance to ensure that they work properly (Wolfgang, 2010).

Besides modifications on the simple pit latrine, there are several other methods of human waste disposal that are feasible to be implemented in squatter communities. Table 6 outlines the advantages and disadvantages of the other engineered treatment methods, and these are described below. Further information regarding these options is located in this chapter and in the manual in Appendix G.

**Table 6: Engineered human waste management options**

<b>System</b>	<b>Type of Wastewater</b>	<b>Advantages</b>	<b>Disadvantages</b>
<b>Septic system</b>	Black water Grey water	Low operating costs, long service life, no flies or odors, easy to use, ensures partial treatment of wastewater	High initial costs, major pathogen runoff, requires sludge removal and treatment, requires input of water
<b>Micro-septic system</b>	Black water	Low costs, no flies or odors, easy to use, ensures partial treatment of wastewater	Requires input of water, requires frequent emptying, major pathogen runoff
<b>Simplified sewerage</b>	Black water Grey water	Appropriate for high population density, easy to use	Very high initial cost, requires construction of a wastewater treatment facility
<b>Dry well</b>	Grey water	Low costs, requires small area of land	Pathogen runoff if groundwater is too high
<b>Percolation trench</b>	Black water Grey water	Easy to use, requires little maintenance	Requires large area of land, pathogen runoff if groundwater is too high
<b>Slow sand filter</b>	Grey water	Effluent can be used for irrigation or surface discharge, low costs	Clogging of filter is possible, requires routine maintenance
<b>Constructed wetland</b>	Grey water	Low costs, does not require constant maintenance, effluent can be used for irrigation or surface discharge	Requires large area of land, inconsistent performance based on rainfall, plants are sensitive to chemicals that may be present in grey water

A septic system is an on-site human wastewater management option that consists of a pipe from the residence, a septic tank, a drainage field, and soil. All wastewater is transported from the residence to the septic tank by a pipe. A septic tank is a large container in which sewage is collected and decomposed by anaerobic bacteria. It is watertight and typically underground. Solid waste particles settle to the bottom of the septic tank, referred to as sludge, and grease and oil rise to the top of the tank, also known as scum (see Figure 19). The effluent can be pumped from the septic tank into the drainage field, where it is then treated by the soil through percolation. However, the effluent is only partially treated and pathogens remain. Septic tanks require routine removal of the sludge and scum, generally every two to five years. If the sludge and scum are not removed, overflow can occur and flood the property with raw sewage. Overflow is very expensive to clean and can result in adverse health effects, such as hepatitis. Due to the risk of overflow, annual monitoring is required. A micro-septic tank operates the same way as a normal septic tank, but is much smaller and can hold less wastewater. For this

reason, it is only meant to treat black water. It must be emptied every one to two years. All types of septic tanks require an expert for sizing and construction (Frenoux, 2011; US EPA, 2002).

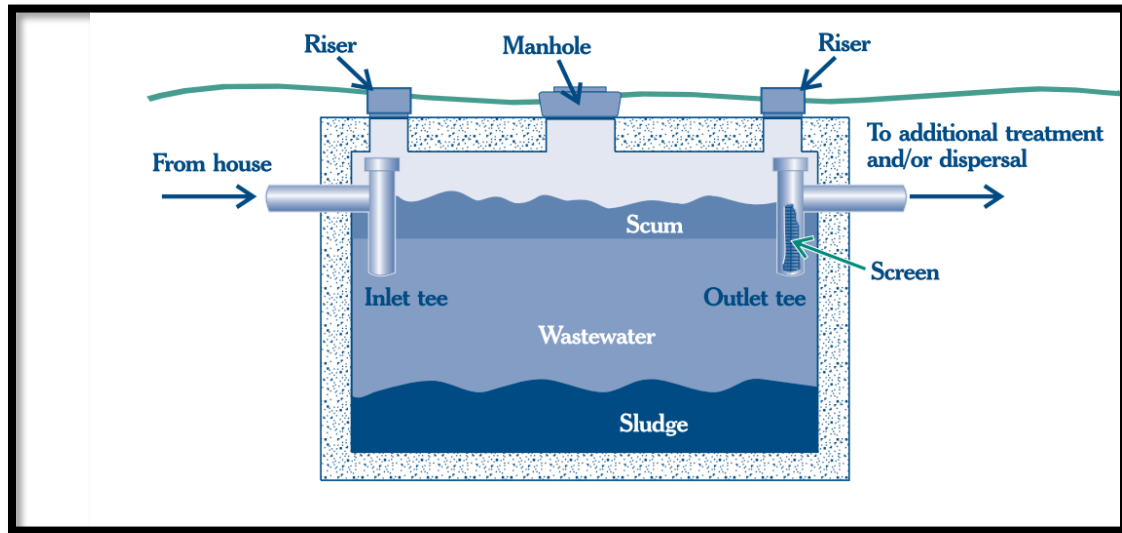

**Figure 19: Septic tank diagram (US EPA, 2002)**

A dry well is a grey water management option that consists of a pit containing gravel. The pit must be located above the water table so it remains dry. Grey water is directly discharged into this pit, where it percolates through the gravel and soil. Disposing of grey water into a dry well is useful in reducing the volume of excess wastewater on land or in surface water. Dry wells are only useful in areas that are not at risk of flooding and where the soil is permeable. Dry wells must be cleaned out if they are clogged by materials such as grease and soap. A grease trap can also be implemented to reduce the frequency of cleaning (Frenoux, 2011).

Percolation trenches, also known as infiltration trenches, can be used to dispose of grey water or pretreated effluent. They are similar to dry wells because they treat wastewater by percolation. They consist of a shallow canal filled with gravel, as shown in Figure 20. Wastewater percolates through the gravel and the soil at the sides and bottom of the trench. Like dry wells, percolation trenches are not appropriate for areas in which flooding is common (Minnesota Small Urban Sites, 2001; US EPA, 1999a).

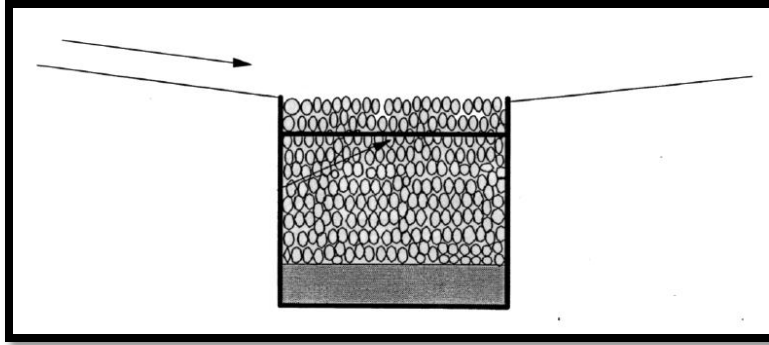

**Figure 20: Percolation trench diagram (US EPA, 1999a)**

Slow sand filters are used to separate suspended solids from wastewater using granular particles, such as sand and ash. Slow sand filters are commonly used to treat grey water, but can be used to filter pretreated black water. A slow sand filter consists of a diffuser plate, granular particles that increase in size towards the bottom of the container, and a spout. An example of a slow sand filter called the Mor-sand filter is shown in Figure 21. Slow sand filters produce effluent that can be used to irrigate plants. Construction costs are low; however, regular manual maintenance is required. It is possible that a slow sand filter can clog with material (US EPA, 1999b).

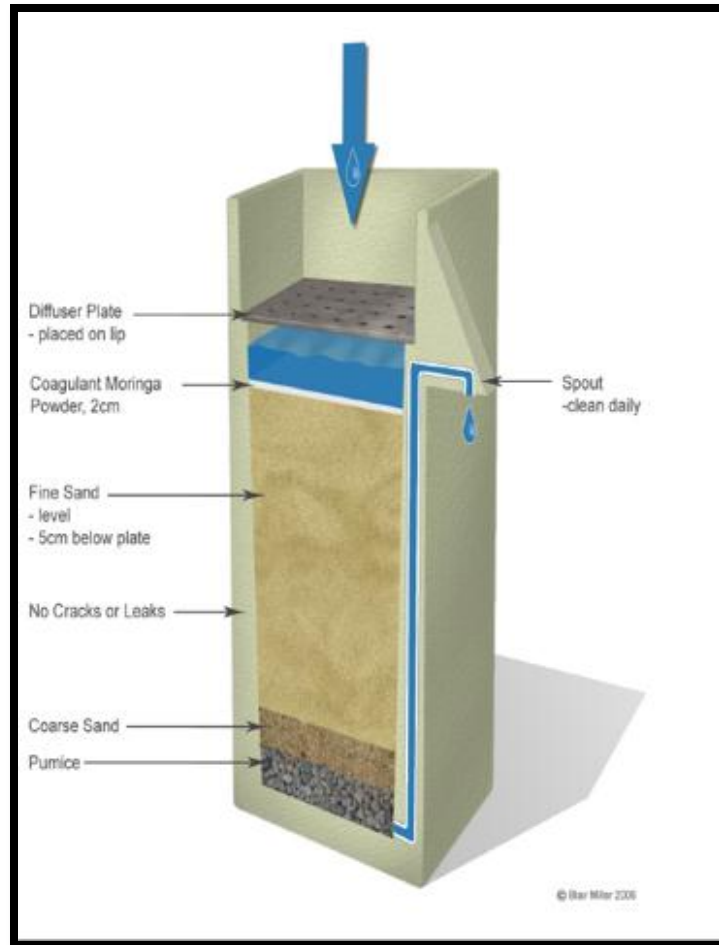

**Figure 21: Mor-sand filter diagram (Rural Africa Water Development Project, 2011)**

Constructed wetlands, also referred to as reed beds or biogardens, allow water to flow through vegetation slowly, filtering out suspended solids. Microorganisms that live in wetlands degrade other pollutants in the water, such as nitrogen and phosphorus. Plants used are indigenous to the location in which the wetland is constructed. Wetlands are reliable and do not require much maintenance. Grey water and pretreated black water can be treated by constructed wetlands (DuPoldt, 1994; US EPA, 2004).

Conventional sewage systems transport wastewater from a residence off-site to a wastewater treatment facility. Sewage is transported through pipes, by gravity or a vacuum. The size of the pipes depends on the population in which the sewage system is serving and the volume of wastewater produced. Simplified sewage systems function in the same manner as conventional sewage systems, but pipe size is reduced and pipes are closer to the surface of the ground, which reduces costs. A simplified sewage system is ideal for communities in which a



conventional sewage system is too expensive, but on-site treatment facilities are inappropriate due to land constraints and population density (Burian, 2005; Lüthi, 2008).

#### **4.4 Community Selection**

Survey results showed that 17% of households in Vida Nueva and 21% in Ramal 7 have no human waste management plan. Coincidentally, these two communities are furthest along in UTPMP's second phase social inclusion program. This indicates that waste management plans implemented in these communities have the highest chances of success. This is important because UTPMP has just begun addressing the need for improved waste management in squatter communities; a successful example would benefit the organization in developing plans for the future. Through personal communication with UTPMP volunteers, we determined that both communities have strong leadership and the residents are motivated to improve their quality of life. Environmental programs are included in the second phase, and encouraging residents to properly dispose of waste will allow the communities to develop in a positive direction. Therefore, UTPMP chose these two communities as examples for demonstrating the use of the waste management plans. Vida Nueva is a representation of an urban squatter community and Ramal 7 represents a rural squatter community. UTPMP wanted the examples to reflect how the manual can be used in diverse communities; therefore, they wanted communities in different settings. The recommendations for these two communities are provided in the following chapter.

## **CHAPTER 5: CONCLUSIONS AND RECOMMENDATIONS**

This chapter presents the specific recommendations for Ramal 7 and Vida Nueva developed using the manual presented in Chapter 4. Our results show that waste management is a pressing issue in these squatter communities. Residents of Ramal 7 and Vida Nueva lack improved waste management strategies based on standards defined by the WHO. The common sanitation practices in these squatter communities are unlined pit latrines and pipes leading to rivers. In Ramal 7, 59% use latrines and 18% use pipes, leaving 23% with no method of disposal, or open defecation. In Vida Nueva, 42% use latrines, 41% use pipes, and 17% resort to open defecation. Common methods of solid waste disposal are informal burning, collecting in open dumps, disposing into rivers, or receiving irregular municipal collection. Based on the waste management manual discussed in Chapter 4 and presented in Appendix G, we developed recommendations for these communities as described below.

### **5.1 Solid Waste Management Examples**

To reiterate, the criteria for evaluating solid waste management strategies in squatter communities were cost and land requirements because of the variation in these factors between options. Each alternative we identified was specific to different types of solid waste. For example, composting is only suitable for organic waste, while recycling is only used for items that can be reused.

Based on our research and evaluation of each alternative solution, our recommended waste management plan for Ramal 7 and Vida Nueva is a combination of recycling, composting, and receiving municipal collection. In Ramal 7, the residents recycled at the school, however, UTPMP volunteers are unsure about where the recyclables are brought after they are collected. UTPMP volunteers believe that when the waste is collected by the municipality, all waste is ultimately combined in a landfill, including recyclables. Because of this, we recommend that the residents of Ramal 7 continue collecting their recyclables at the school and designate an individual to transport them to the local collection center located in the municipality of Matina. The community may be able to make a profit from their recyclable materials by returning them to the local collection center. We also recommend that the residents of Vida Nueva recycle. They can develop a central collection location in the community to store recyclables, and also

designate an individual to transport the recyclables to the local collection center in the municipality of Tres Ríos to sell the materials and potentially generate a profit. These collection bins can be located outside the community building located in the center of the community. We inquired with both municipalities about the value given to recyclables, but our calls were not returned. In the municipality of San José, there is a market for recyclables. UTPMP volunteers believe that there is a recyclable collection center in every municipality in Costa Rica.

The second component of the solid waste management plan is composting, which also contributes to reducing the overall volume of waste. We recommend that the families in both communities individually compost due to lack of available space in the communities for a centralized composting center. In Ramal 7, we recommend that they construct their composting bin 2 meters above the ground to avert the possibility of it being flooded. Families can either use the compost in their gardens or potentially sell the compost and generate a profit. UTPMP volunteers have expressed interest in becoming a liaison between the community residents and potential compost buyers. The potential compost buyers in each region vary based on the businesses in the area as well as the local farmers. The residents can utilize fast composting and customize the bin size to their needs. Fast composting allows the families to produce compost in less time, therefore resulting in a quicker profit return. We suggest that the community leaders stay in contact with UTPMP volunteers and the potential buyers to assess the demand for compost locally.

The third component of the solid waste management plan is municipal trash collection for inorganic and non-recyclable materials. The current irregular and unreliable trash collection results in excess solid waste polluting the streets and rivers. If community members paid the municipalities for trash collection, the service would be more regular. According to the Municipality of Tres Ríos, trash collection costs ₡2,500 CRC (\$5 USD) per household monthly to receive collection service twice per week. Phone calls made to the municipality of Matina were not returned. Although information regarding compost and recycling prices was not available, profit generated by composting and recycling can be put toward paying for municipal trash collection services. According to the survey results regarding finances presented in Chapter 4, it is feasible for some households to afford this service. Therefore, the overall volume of waste in the community can be reduced by having the families that can afford the service receive municipal trash collection.

## 5.2 Human Waste Management Examples

Improving human waste management was a more pressing issue than improving solid waste management in squatter communities. This is because of the high health risk associated with improperly treated sewage. Ramal 7 presents a unique challenge in determining what human waste management technique is appropriate because Limón province receives the most annual rainfall and flooding is prevalent. Many human waste management systems are inappropriate for use in areas that are prone to flooding.

Through our research, we were unable to determine the proximity of the groundwater to the surface of the land in Vida Nueva. Therefore, we assumed the water table was less than two meters deep because of the rainfall Costa Rica receives annually. We decided it was better to be cautious in our recommendations in order to present what we believe will be the most successful plan. Therefore, we are providing the same recommendations for both communities to accommodate any possible flooding.

The 10 sanitation solutions in our waste management manual were compared in an evaluation matrix, shown in Table 7, to determine which human waste management option would be best in each community. We compared our options against 4 different categories: required space, efficiency, pathogen runoff, and ease of maintenance. We evaluated each category on a 0-100 scale with 0 being the least desirable and 100 being the ideal. Once each option was ranked in every category, we totaled the score for each option. The highest scores for both black water and grey water were evaluated against each other. The final options were then compared and the best options for each community were chosen.

**Table 7: Numerical evaluation matrix for sanitation**

<b>Waste Management Options</b>	<b>Space</b>	<b>Efficiency</b>	<b>Pathogen</b>	<b>Maintenance</b>	<b>Total</b>
Pit Latrine	100	10	10	80	200
Ventilated Improved Pit Latrine	100	20	10	80	210
Pour-flush Latrine	100	30	10	80	220
Composting Latrine	80	50	90	60	280
Composting Latrine with Urine Diversion	80	60	80	60	280
Septic Tank	70	70	40	50	230
Sand Filter	100	100	90	80	370
Constructed Wetland	10	80	80	80	250
Percolation Trench	10	100	70	70	250
Dry Well	80	100	90	70	340

For black water treatment, standard composting latrines and composting latrines with urine diversion were ranked as the best options with scores of 280. The advantages and disadvantages of the two options were compared and we determined that the composting latrine with urine diversion costs more than the standard composting latrine and also completes the composting process faster. Standard composting latrines produce higher quality compost because of the additional nutrients urine provides (Huuhtanen, 2006). Therefore, we determined that a ventilated two-vault composting latrine would be the most suitable for Ramal 7 and Vida Nueva. To address frequent flooding of Ramal 7 and the possible high water table in Vida Nueva, we recommend that the basic design is modified by raising the latrine 2 meters above the earth using a watertight, concrete foundation. Composting latrines do not require additional treatment of human waste, they produce compost, and they are permanent structures. Odors and fly problems are low and they require little maintenance. They can also be used to dispose of organic solid waste. There is also the possibility that residents could install a urine diversion system on a case-by-case basis if quicker composting is desired by the household.

Because composting latrines only treat black water, we also used the numerical evaluation matrix for sanitation, previously shown in Table 7, to determine the best grey water treatment option for Ramal 7 and Vida Nueva. Through our rankings, the two most suitable options for grey water treatment are slow sand filters and dry wells. However, due to the possibility of a high water table in both communities, a dry well would not be appropriate. According to the WHO standards, the water table must be at least two meters below the bottom

of the well, which may not be possible in these communities. Therefore, we determined that a slow sand filter would be the most suitable grey water treatment option for Ramal 7 and Vida Nueva. Slow sand filters are contained units and are constructed above ground. They can be raised to accommodate floodwaters. A slow sand filter allows wastewater to percolate through layers of sand and gravel and produces cleaner water, which can be released into the environment safely or reused for non-potable water. Slow sand filters have minimal operation and maintenance costs.

Composting latrines cost under \$470 USD to construct. Slow sand filters cost under \$40 USD when constructed of concrete. The total cost of implementing both of these human wastewater management options is \$510 USD (Lüthi, 2008). Net household monthly income (gross minus expenses) in Ramal 7 is \$276 and in Vida Nueva is \$246. Thus, it would take multiple months for families to afford these options if they put all of their net income toward waste management, and much longer considering other expenditures that have not been accounted for which decrease the net income. We suggest that households share composting latrines initially, therefore reducing the upfront cost. As the funds are available, each household can construct its own latrine. This sanitation system is a permanent structure and operational costs are minimal, so there is little recurring cost. Compost produced by these latrines may also be sold. Although compost can be disposed of without sale, profit is an incentive for residents to improve their current sanitation practices.

### **5.3 Future Recommendations**

The waste management manual can be used in many squatter communities in Costa Rica. We recommend that UTPMP regularly evaluate the success of the implemented waste management systems by monitoring implemented strategies monthly for the first six months, and biannually after that. By evaluating the solutions, we hope that they will be able to improve the implementation methods used in other communities.

We recommend that the manual be continually updated by international and national standards. We used research specific to developing communities to develop the manual. Additions and modifications specific to squatter communities can be added as the organization sees fit. As the communities develop, residents may be able to upgrade their waste management

systems. The manual we created can include all possible waste management options, not only those we determined were feasible currently in the squatter communities we assessed.

For future work with waste management, relationships between squatters and potential buyers of compost can be established. We were unable to collect information on a compost market surrounding the communities we observed. In the future, this would be beneficial for both UTPMP and the communities because it could generate income. Solidifying a market for compost could increase the motivation in the community to improve their waste management practices.

Successful implementation of improved waste management systems can reduce adverse health effects and environmental problems in squatter communities. UTPMP has expressed interest in sharing the manual with other branches of the organization throughout Latin America. We hope the manual and recommendations will help improve the lives of residents in the squatter communities where UTPMP works.

## GLOSSARY

**Absolute poverty:** Inability to afford basic human needs, which commonly includes clean and fresh water, nutrition, health care, education, clothing, and shelter

**Anaerobic:** Pertaining to or caused by the absence of oxygen.

**Berm:** A mound or bank of earth, used especially as a barrier or to provide insulation

**Black water:** Wastewater containing bodily or other biological wastes, as from toilets, dishwashers, or kitchen drains.

**Cholera:** An acute infectious disease of the small intestine caused by the bacterium *Vibrio cholerae* and characterized by profuse watery diarrhea, vomiting, muscle cramps, severe dehydration, and depletion of electrolytes.

**Chronic diarrhea:** Loose stools that last for at least four weeks

**Clogging:** To hinder or obstruct with thick or sticky matter; choke up

**Compost:** A mixture of organic residues such as decomposed vegetation, manure, etc, used as a fertilizer.

**Compost:** A mixture of various decaying organic substances, as dead leaves or manure, used for fertilizing soil.

**Composting:** To convert (vegetable matter) to compost

**Disposal:** The act or means of getting rid of something

**E. Coli:** A bacillus (*Escherichia coli*) normally found in the human gastrointestinal tract and existing as numerous strains, some of which are responsible for diarrheal diseases.

**Efficiency:** Referring to amount of odor and flies present; high efficiency means low odor and low amount of flies, low efficiency means high odor and high amount of flies

**Effluent:** This is a liquid resulting from the storage or treatment of wastewater and excreta that has already undergone partial or complete treatment. Depending on the level of treatment already applied, it can be used or discharged, or have to undergo further treatment.

**Excreta:** Waste matter, such as urine, faeces, or sweat, discharged from the body

**Grey water:** Wastewater produced from human activity such as baths and showers, clothes washers, and lavatories.

**Groundwater table:** The upper limit of the saturated soil body

**Groundwater:** Water that collects or flows beneath the Earth's surface, filling the porous spaces in soil, sediment, and rocks. Groundwater originates from rain and from melting snow and ice and is the source of water for aquifers, springs, and wells.

**Hepatitis:** Inflammation of the liver caused by a virus or a toxin and characterized by jaundice, liver enlargement, and fever.

**Improved sanitation:** An improved sanitation facility is defined as one that hygienically separates human excreta from human contact



**Infrastructure:** The fundamental facilities and systems serving a country, city, or area, as transportation and communication systems, power plants, and schools.

**Latrine:** A receptacle (as a pit in the earth) for use as a toilet.

**Municipal collection:** The governmental gathering of solid waste and recyclable materials and transporting them to the location where the collection vehicle is emptied.

**Organic waste:** The organic waste stream is composed of waste of a biological origin such as paper and cardboard, food, green and garden waste, animal waste and biosolids and sludges.

**Pathogen:** An agent that causes disease, especially a living microorganism such as a bacterium or fungus.

**Percolation:** To cause (liquid, for example) to pass through a porous substance or small holes; filter

**pH:** The acidity or alkalinity of a solution on a scale of 0 to 14, where less than 7 represents acidity, 7 neutrality, and more than 7 alkalinity.

**Poverty:** The state or condition of having little or no money, goods, or means of support

**Recyclable:** Capable of being used again

**Recycle:** To treat or process (used or waste materials) so as to make suitable for reuse

**Runoff:** Something that drains or flows off, as rain that flows off from the land in streams

**Sanitation:** The promotion of hygiene and prevention of disease by maintenance of sanitary conditions (as by removal of sewage and trash)

**Scum:** A filmy layer of extraneous or impure matter that forms on or rises to the surface of a liquid or body of water.

**Sewage:** The contents of a sewer or drain; refuse liquids or matter carried off by sewers

**Sludge:** Semisolid material such as the type precipitated by sewage treatment

**Solid waste:** Solid or semisolid, nonsoluble material (including gases and liquids in containers) such as agricultural refuse, demolition waste, industrial waste, mining residues, municipal garbage, and sewage sludge.

**Squatter community:** A group of individuals who settle on land or occupy property without title, right, or payment of rent

**Squatter:** A person who settles on land or occupies property without title, right, or payment of rent

**Surface water:** Water naturally open to the atmosphere; water from estuaries, lakes, ponds, reservoirs, rivers, seas, etc.

**Typhoid:** Also called typhoid fever. an infectious, often fatal, febrile disease, usually of the summer months, characterized by intestinal inflammation and ulceration, caused by the typhoid bacillus, which is usually introduced with food or drink.

**Ventilation:** a system or means of providing fresh air

**Wastewater:** Water that has been used, as for washing, flushing, or in a manufacturing process, and so contains waste products

## REFERENCES

- Boutin, V., Butler, C., Kesseli, S., & McCorry, M. C., (2011). Improving water quality and sanitation in rural Namibian communities. Worcester, MA: Interactive Qualifying Project at Worcester Polytechnic Institute. [Online]
- Burian, S. J., Nix, S. J., Pitt, R. E., & Durrans, S. R., (2005). Urban wastewater management in the United States: Past, present, and future. *Journal of Urban Technology*, 7(3), 33-62. [Online].
- Cable, R., (2007). Costa Rican humanitarian foundation. Retrieved October 5, 2011, from <http://www.crhf.org/lacarpio.html>
- Calvert, P. (2005). Compost toilets. Warwickshire, UK: The Schumacher Centre for Technology & Development. [Online]
- CDC. (2009). Assessing access to water and sanitation. Retrieved November 2, 2011, from: <http://www.cdc.gov.ezproxy.wpi.edu/healthywater/global/assessing.html>
- Chatterton, K. (2002). Emergency sanitation: Assessment and programme. Design, Water, Engineering and Development Centre Loughborough University. Retrieved from <http://helid.digicollection.org/en/d/Js2669e/1.html>
- CIA (2011). The world factbook: Costa Rica. Retrieved November 2, 2011, from <https://www.cia.gov/library/publications/the-world-factbook/geos/cs.html>
- Costa Rica Guide (2006). Costa Rica rainy season map [Map], Retrieved November 1, 2011, from: <http://costa-rica-guide.com/Weather/WeatherMap.html>
- Crabb, J. (2003). Neither here nor there: Nicaraguans in Costa Rica. Retrieved October 4, 2011, from <http://www.facesofcostarica.com/economics/nicaraguans.htm>
- Davis, M. L., & Masten, S. J. (2009). Wastewater treatment. In *Principles of Environmental Engineering and Science* (Second Edition ed., pp. 457-481). New York, NY: McGraw-Hill.
- DuPoldt, C., Edwards, R., Garber, L., Isaacs, B., Lapp, J., Murphy, T., Webster, H. (1994). A handbook of constructed wetlands. Washington, D.C.: United States Government Printing Office. [Online]

- Frenoux, C., Gabert, J., Guillaume, M., & Monvois, J. (2011). How to select appropriate technical solutions for sanitation. Cotonou and Paris: Partenariat pour le Développement Municipal (PDM) and Programme Solidarité Eau (pS-Eau). [Online]
- Heinemann, A. (2010). *Urban poverty, social exclusion and social housing finance the case of PRODEL in Nicaragua*. Lund: Lund University. [Online]
- Hughes, R. (2010, Solid waste law inked. Costa Rica Business News, Retrieved from <http://fjatevos.com/latest-articles/the-nation/109-solid-waste-law-inked.html>
- Huhtanen, S., & Laukkanen, A. (2006). A guide to sanitation and hygiene for those working in developing countries. Tampere, Finland: Tampere Polytechnic University of Applied Sciences Publications. [Online]
- INEC (2010). Censo 2010. Retrieved November 2, 2011, from <http://www.inec.go.cr/Web/Home/pagPrincipal.aspx>
- Into Costa Rica (2009). Provincias Costa Rica [Map]. Retrieved December 13, 2011, from: [http://www.intocostarica.com/provincias\\_costa\\_rica.htm](http://www.intocostarica.com/provincias_costa_rica.htm)
- Kovaleski, S. F. (1998). There is no law here: Fear in rural Costa Rica: FINAL edition. The Washington Post, pp. A.11. [Online]
- Lüthi, C., Morel, A., Schertenleib, R., Tilley, E., & Zurbrügg, C. (2008). Compendium of sanitation systems and technologies. (Report No. 978-3-906484-44-0). Switzerland: Eawag-Sandec. [Online]
- Mager, M. (2006). Reciclaje y emprendimiento en la gestión de residuos sólidos en Costa Rica. San José, Costa Rica: Programa Competitividad y Medio Ambiente (CYMA). [Online]
- McDonald, M. (2010), Chinchilla signs waste management law. Tico Times, Retrieved from [http://www.ticotimes.net/dailyarchive/2010\\_07/0716103.cfm](http://www.ticotimes.net/dailyarchive/2010_07/0716103.cfm)
- Mendelsohn, R. (1994). Property rights and tropical deforestation, Vol. 46, 750-756. Oxford Economic Papers. [Online]
- Minnesota Small Urban Sites. (2001). Infiltration trenches. Barr Engineering Company. [Online]
- Ross, A. (2011). Vivienda solo tiene recursos para atender 14 de 357 precarios. La

Nación. Retrieved from:

<http://www.nacion.com/2011-02-14/EIPais/NotaPrincipal/EIPais2681076.aspx>

Rural Africa Water Development Project. (2011). Mor-sand filter. Retrieved December 1, 2011, from: [http://www.rawdp.org/Home\\_Page.html](http://www.rawdp.org/Home_Page.html)

Shaw, R. (2002). Emergency sanitation: Assessment and programme design. Water, Engineering and Development Centre Loughborough University. Retrieved from <http://helid.digicollection.org/en/d/Js2669e/1.html>

Stoeckel, D. (Hydrologist), & Mancl, K. (Professor), Ohio State University. (2006). Fecal-oral pathogens in water. (Report No. AEX-769-06). Columbus, OH: The Ohio State University Extension. Retrieved November 15, 2011, from <http://ohioline.osu.edu/aex-fact/pdf/0769.pdf>

Sugar Delta. (2011). Costa Rica tour information [Map]. Retrieved November 1, 2011, from <http://sdawardbook.webs.com/americanpage2.htm>

Swedish Cooperative Center. (2007). Expertos internacionales hablan sobre precarios en Costa Rica. Retrieved from <http://www.sccportal.org/Programas/Vivienda/Archivo-noticias-vivienda.aspx?M=News&PID=1317&NewsID=807>

Torfaen County Borough Council. (2010). Composting [Diagram], Retrieved November 28, 2011, from <http://www.torfaen.gov.uk/EnvironmentAndPlanning/RubbishWasteAndRecycling/Composting/Images/How%20Compost%20Happens.gif>

Trackman, B., Fisher, W., & Salas, L. (1999). The reform of property registration systems in Costa Rica: A status report. Retrieved November 5, 2011, from: <http://www.incae.edu/es/clacds/publicaciones/pdf/cen1900-hiid.pdf>

United States Department of State. Background notes: *Costa Rica*. (2011). Retrieved September 12, 2011 from <http://www.state.gov.ezproxy.wpi.edu/r/pa/ei/bgn/2019.htm>

Un Techo Para Mi País (2011). Homepage. Retrieved on October 18, 2011, from: <http://www.untechoparamipais.org/english/>

- US EPA. (1998). Constructed wetlands design manual (Report No. EPA/625/1-88/022).  
Washington, D.C.: Office of Research and Development. [Online]
- US EPA. (1999a). Storm water technology fact sheet infiltration trench. (Report No. EPA 832-F-99-019). Washington, D.C.: Office of Water. [Online]
- US EPA. (1999b). Wastewater technology fact sheet intermittent sand filters. (Report No. EPA 932-F-99-067). Washington, D.C.: Office of Water. [Online]
- US EPA. (1999c). Water efficiency technology fact sheet composting toilets. (Report No. EPA 832-F-99-066). Washington, D.C.: Office of Water. [Online]
- US EPA. (2002). A homeowner's guide to septic systems. (Report No. EPA-832-B-02-005).  
Washington, D.C.: Office of Water. [Online]
- US EPA. (2004). Constructed treatment wetlands. (Report No. EPA 843-F-03-013). Washington,  
D.C.: Office of Water. [Online]
- US EPA. (2011a). Resource conservation: Composting. Retrieved from  
<http://www.epa.gov/osw/conserves/rrr/composting/basic.htm>
- US EPA. (2011b). Resource conservation: Recycling. Retrieved from  
<http://www.epa.gov/osw/conserves/rrr/recycle.htm>
- Velazquez, M. R. (2008). Formalization of housing in San José, Costa Rica. University of  
Kansas: Kansas City, Kansas. [Online]
- Villegas, J. S. (2011). Municipios rehúyen obligación de solucionar manejo de basura. La  
Nación, Retrieved December 2, 2011, from: <http://www.nacion.com/2011-06-10/ElPais/NotasSecundarias/ElPais2806172.aspx>
- WHO. (1996). Fact sheets on environmental sanitation. Geneva, Switzerland: WHO Press.  
[Online]
- WHO. (2008). Guidelines for drinking-water quality. Geneva, Switzerland: WHO Press.  
[Online]
- WHO/UNICEF. (2010). Joint Monitoring Programme (JMP) for Water Supply and Sanitation.  
Retrieved November 2, 2011, from <http://www.wssinfo.org/>

Wolfgang, B., Deutsche gesellschaft für technische zusammenarbeit (2010). Basic Overview of Composting Toilets. Retrieved December 4, 2011 from:

<http://www.gtz.de/en/dokumente/gtz2010-en-technology-review-composting-toilets.pdf>

The World Bank. (2010). Extreme poverty rates continue to fall. Retrieved from:

<http://data.worldbank.org/news/extreme-poverty-rates-continue-to-fall>

Wright, M., (1996). Safe use of household greywater. Las Cruces, New Mexico: New Mexico State University. [Online]

## APPENDIX A: WHO Sanitation Ladder



## **APPENDIX B: First Phase Survey Questions - Vida Nueva, Ramal 7, Barrio Nuevo, Cristo Rey**

How many people live in your house? \_\_\_\_\_

What is your monthly income (colones)? \_\_\_\_\_

What type of sanitary service do you have in your house?

- a. Latrine
- b. Pipe
- c. None

What is your water source?

- a. Own Pipe
- b. Own Pipe (irregular)
- c. Communal tap
- d. Private well
- e. Public well
- f. Natural source (river, rain, etc)
- g. Other (which)
- h. None

Who owns the land you live on?

- a. Own, has papers
- b. Own, no papers
- c. State
- d. City
- e. Private
- f. Rented (from whom)
- g. Borrowed (from whom)
- h. Unknown
- i. Other (which)



¿Cuántas personas viven en su vivienda? \_\_\_\_\_

¿Cuánto es su ingreso mensual (colónes)? \_\_\_\_\_

¿Qué tipo de servicio sanitario tiene usted en su vivienda?

- a. Letrina
- b. Tubo
- c. Ninguno

¿Cuál es su fuente de agua? (

- a. Propios de la tubería
- b. Pipe propia (irregular)
- c. Comunidad grifo
- d. Pozo privado
- e. Pozo público
- f. Fuente natural (río, lluvia, etc)
- g. Otros (que)
- h. Ninguno

¿Que tiene la posesión de la tierra que su viven?

- a. Propia, tiene papeles
- b. Propia, sin papeles
- c. Estado
- d. Ciudad
- e. Privado
- f. Alquilados (de quién)
- g. Prestado (de quién)
- h. Desconocido
- i. Otros (que)

## APPENDIX C: First Phase Survey Questions - Guararí

How many people live in your house? \_\_\_\_\_

What is your monthly income (colones)?

- a. More than 75,000
- b. 55,000 – 75,000
- c. 40,000 – 55,000
- d. 25,000 – 40,000
- e. Less than 25,000

Do you have access to potable water?

- a. Yes
- b. No

Do you own the land you live on?

- a. Yes
- b. No

¿Cuántas personas viven en su vivienda? \_\_\_\_\_

¿Cuánto es su ingreso mensual (colones)?

- a. Más de 75,000
- b. 55,000 – 75,000
- c. 40,000 – 55,000
- d. 25,000 – 40,000
- e. Menos de 25,000

¿Tiene usted acceso a agua potable?

- a. Sí
- b. No

¿Es usted el propietario de la tierra vive usted?

- a. Sí
- b. No

## **APPENDIX D: Second Phase Survey Key - Cristo Rey, Vida Nueva, and Ramal 7**

Question P15: What type of sanitary service do you have in your house?

- A. Toilet connected to sewerage
- B. Toilet connected to septic tank
- C. Sanitary latrine connected to a black pit
- D. Box going to small body of water
- E. Box going to canals
- F. Do not have it
- G. Other (specify)

Question P17: Where does the water you use in your house come from?

- A. Faucet in the house
- B. Faucet on site, but away from the house
- C. Delivered from external sources
- D. Comes from a well from another source
- E. Do not have it
- F. Other (specify)

### Módulo de vivienda

*Preguntar al entrevistado, las siguientes características de su vivienda*

N°	Pregunta	Posibles respuestas para completar la planilla	
P15	¿Qué clase de servicio sanitario dispone su vivienda?	A. Inodoro conectado a Alcantarillado B. Inodoro conectado a Fosa Séptica C. Letrina sanitaria conectada a pozo negro	D. Cajón sobre rozo negro E. Cajón sobre acequias, canales F. No tiene G. Otro (especificar)

P17	¿De dónde viene el agua que utiliza en su vivienda?	A. Llave dentro de la vivienda B. Llave dentro del sitio, pero fuera de la vivienda C. Entregada por externos	D. La acarrea (traer de pozo u otra fuente) E. No tiene F. Otro (especificar)
P18	¿De que forma elimina usted la basura?	A. Servicio pagado B. Servicio gratuito C. La traslada (a un lugar adecuado) D. La tira (en un lugar no apto)	E. La quema F. La entierra G. Otro (especificar)

## **APPENDIX E: Second Phase Survey Questions - Cristo Rey, Vida Nueva, and Ramal 7**

Question P1: Name

Question P15: Sanitary services

Question P17: Potable water

Question P18: Garbage disposal

Question P38: Annual income occupation 1; Annual income Occupation 2

Question P38D: Total external income per person

Question P39C: Annual expenditures



## Encuesta Habilitación Social

### Módulo de información general

Dirección de la vivienda:

Provincia:

Nombre del encuestador:

Comunidad:

País:

Número telefónico:

	P1			P2	P3	P4	P5	P6. Teléfono		P7	P8
	Nombres	Apellido 1	Apellido 2	Identificación	Nacimiento (dd/mm/aa)	Sexo	Dirigente vecinal	Red fija	Móvil	E-mail	Relación
1						F M	Si No				A B
2						F M	Si No				A B
3						F M	Si No				
4						F M	Si No				
5						F M	Si No				
6						F M	Si No				
7						F M	Si No				
8						F M	Si No				
9						F M	Si No				
10						F M	Si No				

Observaciones:

### Módulo de vivienda

	Problemas	Respuesta	Observaciones
P15	Servicio sanitario	A B C D E F G	
P16	Alumbrado	A B C D E F G	
P17	Agua potable	A B C D E F	
P18	Recolección basura	A B C D E F G	
P19	Combustible cocina	A B C D E F	
P20	Vías de acceso	A B C D	
P21	Posesión de terrenos	A B C D E F	

### P38. Ingresos ocupacionales

	Ocupación principal					Ocupación secundaria					P38C	
	P38A		P38B		Ingreso anual ocupación 1	P38A		P38A		Ingreso anual ocupación 2		
	Ingreso diario	Frecuencia días	Ingreso mes	Frecuencia meses		Ingreso diario	Frecuencia días	Ingreso mes	Frecuencia meses			
1		1 2 3 4 5 6 7		1 2 3 4 5 6 7 8 9 10 11 12			1 2 3 4 5 6 7		1 2 3 4 5 6 7 8 9 10 11 12			
2		1 2 3 4 5 6 7		1 2 3 4 5 6 7 8 9 10 11 12			1 2 3 4 5 6 7		1 2 3 4 5 6 7 8 9 10 11 12			
3		1 2 3 4 5 6 7		1 2 3 4 5 6 7 8 9 10 11 12			1 2 3 4 5 6 7		1 2 3 4 5 6 7 8 9 10 11 12			
4		1 2 3 4 5 6 7		1 2 3 4 5 6 7 8 9 10 11 12			1 2 3 4 5 6 7		1 2 3 4 5 6 7 8 9 10 11 12			
5		1 2 3 4 5 6 7		1 2 3 4 5 6 7 8 9 10 11 12			1 2 3 4 5 6 7		1 2 3 4 5 6 7 8 9 10 11 12			
<b>Total ingresos ocupacionales del hogar en un año:</b>												



**Ingresos externos**

	P38D									P38E Total ingreso externo por persona
	Por parte del Estado			Por remesas			Otros ingresos			
	Ingreso mes	Frecuencia meses	Ingreso anual	Ingreso mes	Frecuencia meses	Ingreso anual	Ingreso mes	Frecuencia meses	Ingreso anual	
1		1 2 3 4 5 6 7 8 9 10 11 12			1 2 3 4 5 6 7 8 9 10 11 12			1 2 3 4 5 6 7 8 9 10 11 12		
2		1 2 3 4 5 6 7 8 9 10 11 12			1 2 3 4 5 6 7 8 9 10 11 12			1 2 3 4 5 6 7 8 9 10 11 12		
3		1 2 3 4 5 6 7 8 9 10 11 12			1 2 3 4 5 6 7 8 9 10 11 12			1 2 3 4 5 6 7 8 9 10 11 12		
4		1 2 3 4 5 6 7 8 9 10 11 12			1 2 3 4 5 6 7 8 9 10 11 12			1 2 3 4 5 6 7 8 9 10 11 12		
5		1 2 3 4 5 6 7 8 9 10 11 12			1 2 3 4 5 6 7 8 9 10 11 12			1 2 3 4 5 6 7 8 9 10 11 12		
<b>Total ingresos externos del hogar en un año:</b>										

P38F. Total ingresos del hogar en un año (ocupacionales + externos)

**P39. Gastos**

Use las demás líneas cuando haga las correcciones. Indique en observaciones cual fila se debe considerar (con mejor aproximación).

P39B												P39A	P39C
Alimento	Transporte	Servicios	Vivienda	Educación	Salud	Vestuario	Diversión	Deudas	Envíos	Negocio	Otros	Gasto mensual	Gasto anual

Observaciones:

P40. Total ahorro-deuda anual (P38F-P39C)



## APPENDIX F: Second Phase Survey Questions - Guararí

### 2. Principal Questions

List all family members residing in the home, starting with the head of household (if other than the respondent, the spouse and then the children of highest age to lowest age. WRITE ANSWERS ON THE TABLE BELOW.

Name

- From this, we counted the number of people and determined this to be the number of people in the home.

### 3. Features of the Home

a. What type of toilet do you have? Choose only one.

- Flush toilet
- Private latrine
- Shared latrine
- Septic pit
- None

b. Where does the water you use in your home come from?

- Public stream
- Private stream
- River or natural source
- Well
- Communal well
- Other: \_\_\_\_\_

c. How do you get rid of your garbage?

- Municipal service
- Particular service
- Burn it
- Bury it
- Deposit it in a container
- Throw it in the street
- Throw it in the stream/river

h. Other: \_\_\_\_\_

i. No record

#### 4. Employment information

Complete the following table with information regarding all family members working and residing in the house.

a. Name

b. Estimated income per month, independent of frequency (in colones)

c. What is the monthly income of your house? (sum of salaries of all household members)

## 2. Cuestionario Principal

Listar a todos los miembros de la familia que residen en la vivienda, comenzar con el/la jefe(a) de hogar (en caso que no sea el entrevistado, la pareja y luego los hijos de mayor a menor.

ANOTAR RESPUESTAS EN EL CUADRO INFERIOR.

- a. Nombre

## 3. Características del Hogar

a. Qué clase de servicio sanitario tiene? RESPUESTA ÚNICA (RU)

- a. De lavar (Inodoro)
- b. Letrina Privada
- c. Letrina Compartida
- d. Fosa Séptica
- e. No tiene

b. De dónde proviene el agua que utiliza en su hogar? RU

- a. Pila o chorro public
- b. Pila o chorro privado
- c. Río o fuente natural
- d. Pozo
- e. Pozo comunal
- f. Otro: \_\_\_\_\_

e. De qué forma elimina su familia la basura? RU

- a. Servicio Municipal
- b. Servicio Particular
- c. La quema
- d. La entierra
- e. La deposita en contenedor
- f. La tira en la calle
- g. La tira en quebradas/río
- h. Otro \_\_\_\_\_
- i. NS/NR

#### 4. Características del Empleo

Llenar el siguiente cuadro con la información de todos los miembros de la familia que trabajan y que residen en la vivienda.

b. Nombre

f. Ingreso estimado al mes, independientemente de la frecuencia (colones)

g. ¿Cuanto es el ingreso al mes de su hogar? (suma de sueldos de todos los integrantes del hogar que trabajan? \_\_\_\_\_

## **APPENDIX G: Waste Management Manual**

The following two documents are the waste management manuals we created. The first is in English and the second is in Spanish.

Version

1

UN TECHO PARA MI PAIS- COSTA RICA

---

In cooperation with Worcester Polytechnic Institute



Aaron Behanzin, Caroline Concannon, Olivia Doane, & Mackenzie Ouellette

December 14, 2011

# Waste Management Manual

## Table of Contents

Preface.....	ii
Icon Key.....	iii
Selection Criteria .....	v
Solid Waste Management .....	1
Preface.....	1
Solid Waste Management Decision Table .....	2
Recycling.....	3
Composting.....	4
Refuse Pits .....	8
Municipal Collection .....	9
Human Waste Management.....	10
Preface.....	10
Waste Water Management Decision Table.....	11
Simple Pit Latrine .....	12
Ventilated Improved Pit Latrine (VIP).....	19
Pour- Flush Latrine .....	22
Composting Latrine .....	26
Composting Latrine with Urine Diversion .....	32
Septic System .....	35
Constructed Wetland .....	42
Dry Well .....	50
Percolation Trench.....	55
Sand Filter.....	58
Glossary .....	61
References.....	63











## **Preface**









The following chapters outline feasible solid and human waste management options to be implemented in squatter communities. It allows the community members make an educated decision as to which improved waste management plan is appropriate for them. Each chapter of this manual is prefaced with a table that allows the user to determine visually what solution may be appropriate for the conditions. We included specific instructions on how to construct each solution, how much the plan costs, and how to maintain the system. By implementing an improved waste management system in squatter communities, the quality of lives of the residents can be enriched.



## Icon Key

This table displays the icons that are used in the decision tables included in this manual and the range that each icon depicts.

Limitation	Icon
Available Space	 10 m <sup>2</sup> +
	 5-9 m <sup>2</sup>
	 0-4 m <sup>2</sup>
Cost	 \$601 USD +
	 \$301-600 USD
	 \$0-300 USD
Inorganic waste	
Organic waste	
Recyclable	
Maintenance	 Requires a professional

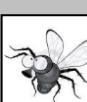
	 Requires moderate skill  Requires little or no skill
<b>Pathogen runoff</b>	 Major  Minor
<b>Longevity</b>	 16+ years  6-15 years  0-5 years
<b>Efficiency</b>	 Major flies and odors  Minor flies and odors

## **Selection Criteria**

In order to select the most appropriate waste management system for a given community, one must address the following criteria:

- Background information on the demographics and cultural practices regarding waste management of the community
- Availability of water to be used in sanitation
- Current waste management practices
- Depth of the water table and proximity of community to the water source
- Climate of community, including annual rainfall and frequency of flooding
- Availability of physical space for a waste management system to be implemented
- Availability of resources, such as finances, professional services, contractors, and manual laborers
- Type of waste produced by the community, such as organic waste and recyclable material

















## **Solid Waste Management**

*The following chapter outlines solid waste management options for communities in Latin American countries.*

### **Preface**

This section of the manual includes data regarding solid waste management practices that could be used in squatter communities. Information about implementation, use, and maintenance for 4 solid waste management options is included. We included only the most feasible solutions for residents of squatter communities. The majority of these options can be implemented and maintained by residents themselves. However, some practices require maintenance from the municipality. The table included in this guide is to be used as a tool to determine the most feasible solution. The majority of the information included in this chapter of the manual is based on the United States Environmental Protection Agency guidelines for Reduce, Reuse, and Recycle in 2011. Additional information was obtained through the sources listed in the references section of this document.

## Solid Waste Management Decision Table





	Type of Waste	Implementation Cost	Recurring Cost	Required Space
Recycling			N/A	
Composting			N/A	
Municipal Collection	  			
Refuse Pit	  		N/A	

## Recycling



Recycling bin

- What materials can be recycled?
  - Glass, plastic, cardboard, aluminum, paper

 <p>Glass</p>	 <p>Plastic</p>	 <p>Cardboard</p>	 <p>Paper</p>
 <p>Aluminum</p>			

- How do I recycle?
  - This method is performed by separating all recyclable materials and driving them to the local collection center in exchange for money
- Why should I recycle?
  - You can make a profit
  - Saves natural resources- takes less energy to make something out of recycled materials
  - Saves space in landfills
- What do I need to consider about recycling?
  - It takes time to do
  - Depending on the local government, a person in the community needs to have a car to be able to take the recyclables to the local collection center

## Composting



**Materials that can be composted (Hall, 2011)**

- What materials can I compost?
  - Brown materials: provides carbon
    - Paper, cardboard, leaves, twigs, soil
  - Green materials: provides nitrogen
    - Grass clippings, vegetable peels, fruit peels, coffee grounds
- What materials can't be composted?
  - Metals, dairy products, meat, plastic, chemical pesticides
- How many people can use a composting bin?
  - Composting can be performed individually or community wide - just vary the size of the bucket used!
  - Can be as small as a plastic bin or as large as a dumpster
- What do I compost in?
  - If composting leaves and outdoor materials
    - A pile outlined by wire or scrap wood
  - If composting food
    - Closed-top bin

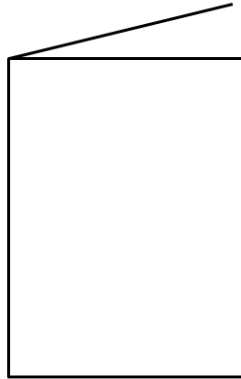

### **Simple composting bin with lid**

- Where should I compost?
  - The best location for a composting bin is in a dry, shady spot near a water source
- How long does composting take to complete?
  - Fast: Takes 6-8 weeks
    - Need enough to fill a full container
    - Water as you fill it
    - Compost will get hot, when it cools down turn it
    - If it is dry add water and if it is soggy add dry material
    - When it no longer heats up again, leave undisturbed to finish composting
  - Slow: Takes up to a year to fully compost
    - Need enough to fill a layer of at least 30 cm
    - To improve air circulation and drainage, put small twigs on the bottom
    - When the lower layers compost it can be used in a garden and mix the rest of compost
    - If it is dry add water and if it is soggy add dry material



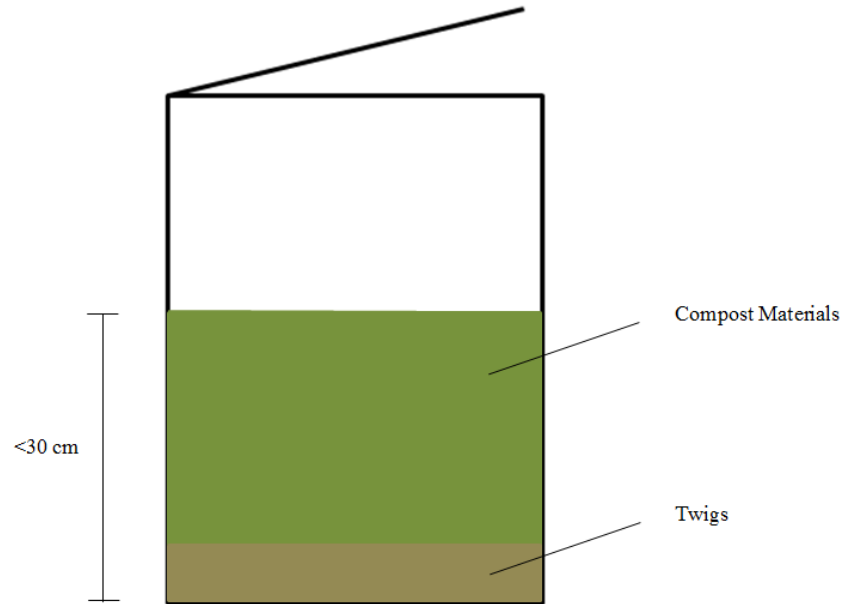

**Slow composting layers**

- Why should I compost?
  - It is profitable
  - Environmentally friendly- reduces the production of methane in landfills
  - It can help enrich your land by introducing microorganisms, reducing the need for fertilizers
- What do I need to consider about composting?
  - Requires work & maintenance
  - Needs space

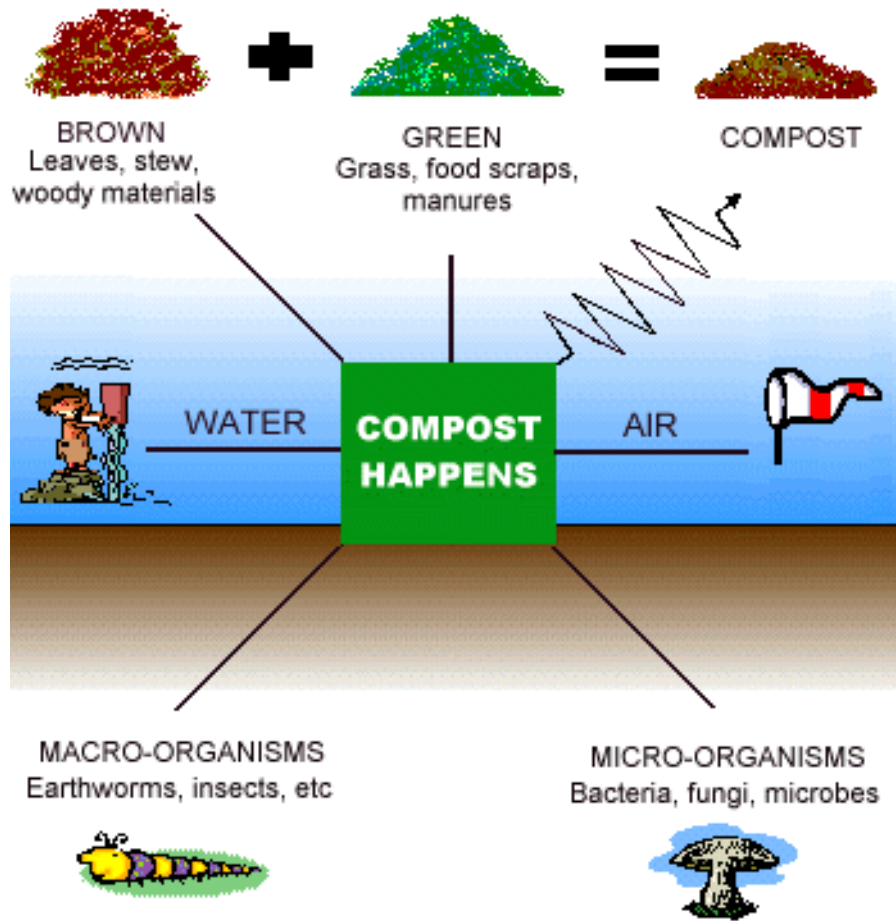

Composting cycle (Torfaen County Borough Council, 2010)

## Refuse Pits

- What materials can be used?
  - All non-recyclable materials
- Where should my pit be located?
  - Above groundwater level to eliminate chemical and hazardous waste contamination
  - At least 20 meters from kitchen area
  - Safe distance away from water source depending on your location
  - Not above any pipe that empties into surface water
  - Pit should have a sealed base to prevent it from contaminating ground water
- Must be covered
  - Children and animals should not have access to a refuse pit due to hazardous materials
- How do I make my pit last?
  - By compacting the pile you can fit more trash in the pit and it will last longer
- Why should I use a refuse pit?
  - It is a good way to compact your waste that can not be disposed of in any other way
  - It is free to use
- What do I need to take into consideration with a refuse pit?
  - It takes up a lot of space
  - Need to be very cautious about health hazards and the location of the pit

## **Municipal Collection**

- What can be collected?
  - All types of waste
- How do I get this service?
  - Pay local municipality for trash collection
    - Cost and regularity vary depending on region
- Why should I get my trash collected?
  - All waste is collected and treated off-site elsewhere
- What do I need to consider about municipal collection?
  - Expensive (continuous cost)
  - Recyclable & compostable material is mixed in with all trash; may be bad for the environment

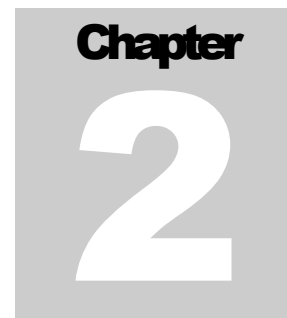













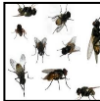













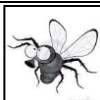



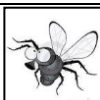















## **Human Waste Management**

*The following chapter outlines human waste management options for communities in Latin American countries.*

### **Preface**

This section of the manual includes data regarding sanitation services that could be used in squatter communities. Information about implementation, use, and maintenance for 10 sanitation systems is included. We included only the most feasible solutions for residents of squatter communities. The majority of these options can be implemented by residents themselves. However, some sanitation practices require professional construction and/or planning. The sanitation practices that fall into the category have been clearly denoted. The table included in this guide is to be used as a tool to determine the most feasible solution. The majority of the information included in this chapter is based on the World Health Organization's Sanitation Fact Sheets published in 2006. Additional information was obtained through the sources listed in the references section of this document.

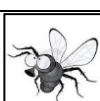
## Waste Water Management Decision Table

	Implementation Cost	Maintenance Cost	Efficiency	Ease of Maintenance	Required Space	Pathogen Runoff	Longevity
Simple Pit Latrine					m <sup>2</sup>	+	
Ventilated Pit Latrine					m <sup>2</sup>	+	
Pour-flush Latrine					m <sup>2</sup>	+	
Composting Latrine					m <sup>2</sup>	-	
Composting Latrine with Urine Diversion					m <sup>2</sup>	-	
Septic System					m <sup>2</sup>	-	
Constructed Wetland					m <sup>2</sup>	-	
Dry Well					m <sup>2</sup>	-	
Percolation Trench					m <sup>2</sup>	-	
Sand Filter					m <sup>2</sup>	-	

## Simple Pit Latrine

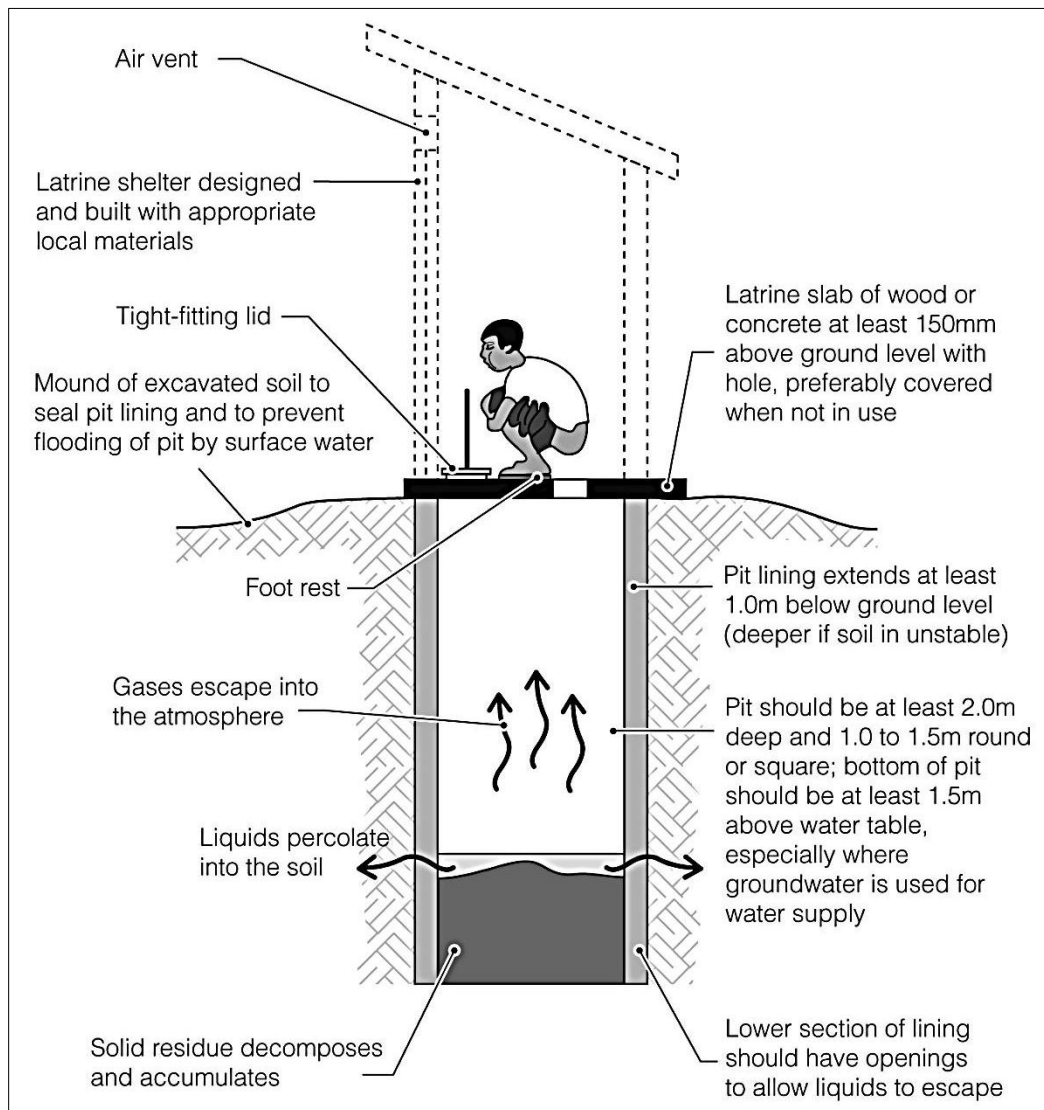

**Simple pit latrine (Image courtesy of WEDC © Ken Chatterton, 2002)**

A simple pit latrine consists of a pit dug into the ground, covered by a hygienic slab or floor with a hole where human waste can pass into the pit. There are many variations on this simple pit latrine, such as including a tight-fitting lid to cover the hole to reduce odors and the breeding of flies. Once the pit is full to 50 cm below the hole, it can be covered and a new simple pit latrine must be created. The pit can also be lined with a variety of materials, including concrete blocks, bricks, and perforated oil drums. It can also be emptied by a professional. The latrine must be cleaned with disinfectant by the users. Simple pit latrines often have a shelter

built from available materials, such as wood and corrugated tin. This shelter only needs to be big enough to house the hole in the ground and one user.

<b>Basic Information</b>	
Average implementation cost	\$50-130 USD
Average annual maintenance cost	\$7-20 USD
Ease of implementation	Easy
Ease of maintenance	Easy
Efficiency	Flies and odors present
Size	Requires 0.06 m <sup>3</sup> of volume per person per year of anticipated use + 0.5 m in depth for covering with soil when full
Lifespan	5-10 years

<b>Advantages</b>	<b>Disadvantages</b>
Low maintenance and implementation costs	Prevalent flies and odors
Easy to build	Major pathogen runoff
Readily available materials	

<b>Limitations</b>
Must be implemented in an area where the water table is at least 2 m from the bottom of the pit and should not penetrate groundwater
Must be constructed at least 30 m from well
Must be constructed at least 30 m from river
Must be constructed about 6 m from home
Should be constructed downhill from water source

## Construction

1. Calculate the volume the pit must contain and dig hole
  - a. For example, a family of 5 that needs to use the pit latrine for 10 years needs a pit latrine that is 1.8 m<sup>3</sup>
    - i.  $0.06 \frac{m^3}{person \times year} \times 5 \text{ persons} \times 10 \text{ years} = 3 m^3$
  - b. The hole must have this volume capacity, plus 0.5 m in depth so that when it fills, it can be covered with soil
  - c. This can be accomplished by creating a rectangular hole 1 m wide, 1 m long, and 3.5 m deep



- d. Hole can be cylindrical or rectangular

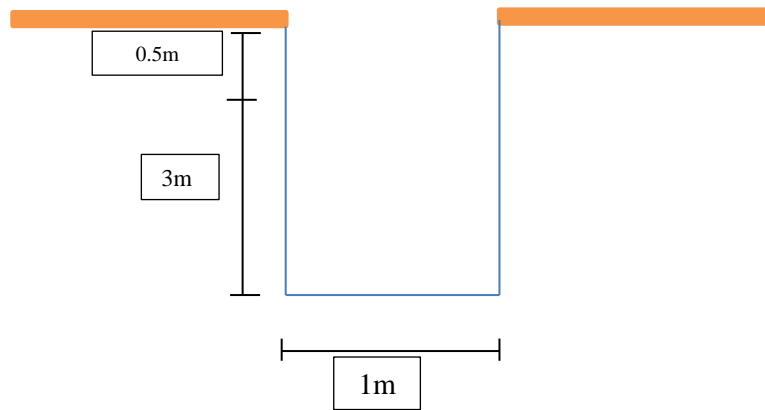

**Simple pit latrine, Step 1**

2. Line the pit

- a. Pits can be lined with concrete blocks, bricks, masonry, stone rubble, perforated oil drums, or rot-resistant timber to provide support for the plate on which the user stands
- b. The amount of materials needed to line the pit depends on the size of the pit
  - i. For example, for a rectangular hole that is 1 m wide, 1 m long and 3.5 m deep, the pit lining would require  $14 \text{ m}^2$  of materials to cover the sides of the pit
  - ii.  $4 \times (1 \text{ m} \times 3.5 \text{ m}) = 14 \text{ m}^2$
- c. Lining should only be mortared 0.5 m from the surface to allow liquid waste to penetrate the soil

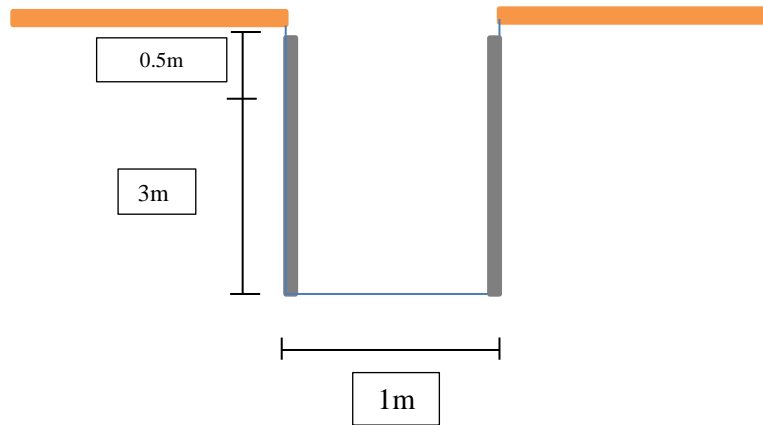

**Simple pit latrine, step 2**

### 3. Foundation

- a. The foundation can be made of concrete, brick, or termite resistant wood
- b. A foundation must be built to support the squatting plate, to prevent flooding by rain water, and to prevent rodents from digging into the pit
- c. It should be over 0.1 m above the level of the ground outside the pit
- d. For example, for a rectangular hole that is 1 m wide, 1 m long and 3.5 m deep and has a foundation that is 0.1 m above the ground needs an additional  $0.4 \text{ m}^2$  materials for the foundation

- i.  $4 \times (1 \text{ m} \times 0.1 \text{ m}) = 0.4 \text{ m}^2$

### 4. Build mound (if necessary)

- a. A mound is necessary if the water table is less than 2 m below the bottom of the pit or the rock is solid, it raises the latrine
- b. The pit walls and lining must be built up at least 1.2 m from the surface of the soil
- c. Concrete is added to support the structure, steps can also be added using cement

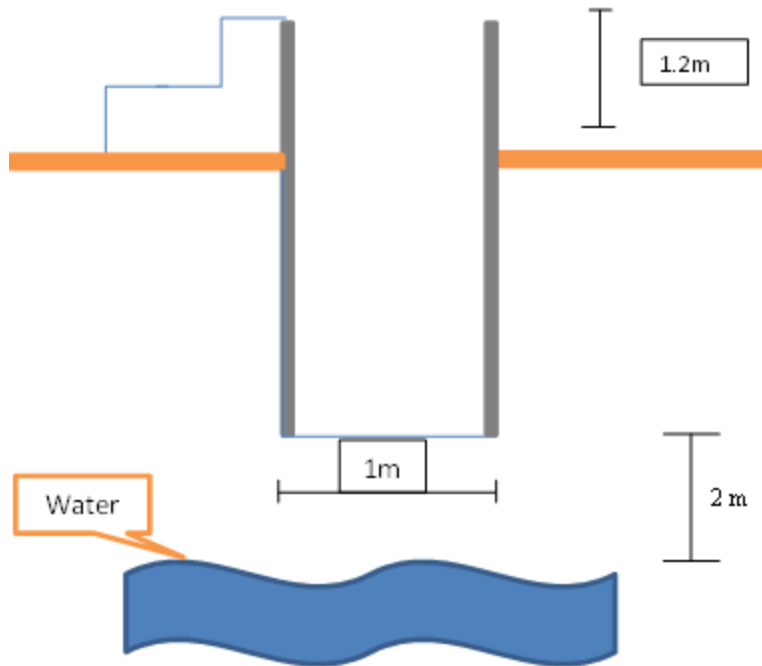

**Simple pit latrine, step 4**

#### 5. Squatting slab

- a. The slab supports the user and covers the pit. For this reason, the slab must be larger than the pit itself
- b. The slab can be made out of wood or concrete. Concrete prevents hookworm infection
- c. The slab must have a hole that the excrement can pass through into the pit
- d. The slope of the slab should slant toward the hole to allow waste to drain into the hole
- e. The opening should be smaller than 0.25 m in any direction to prevent a child from falling into the pit latrine
- f. The slab can have a seat built on top of the hole for comfort or the user can squat above the hole
- g. To build the squatting slab:
  - i. Dig a square shallow hole that is 0.2 m wider and longer than the pit itself and 0.05 m deep
  - ii. Make a wire grid to line the inside of the hole
    1. The wires can be 6 to 9 mm thick and about 0.2 m apart

- iii. Cut a hole about 0.25 m in diameter in the middle of the grid
- iv. Bend the ends of the wires so that the wire grid stands about 20-30 mm off the bottom of the square hole
- v. Put an bucket that is taller than 0.5 m and smaller than 0.25 m in diameter to cast the hole in the slab
- vi. Pour cement into the square hole until it is about 5 cm thick
- vii. Remove the bucket when cement beginning to harden (after about 3 hours)
- viii. Cover the cement with cement bags, sand, hay or plastic and keep it damp for 5 days

#### 6. Lid

- a. A tight-fitting lid is necessary to prevent flies and odors
- b. This lid is usually made of wood and covers the hole
- c. For a circular hole that is 0.25 m in diameter, a lid that is 0.05 m<sup>2</sup> in area is necessary

$$i. \pi\left(\frac{0.25 \text{ m}}{2}\right)^2 = 0.05 \text{ m}^2$$

#### 7. Shelter

- a. The shelter provides privacy for the user and protection from weather
- b. The shelter can be made of any available materials
  - i. Example: bricks, tin

#### 8. Maintenance

- a. The door of the shelter should be kept closed
- b. The squat-hole of the latrine should be kept closed using the lid to prevent flies entering the latrine
- c. The latrine floor should be cleaned daily
- d. Organic waste can be deposited in the latrine (note: will decrease the longevity of the latrine)
  - i. To decrease odors in the latrine, vegetable, fruit peel, sawdust, and leaves can be added in the latrine.
- e. The pit should be kept as dry as possible to stop mosquitoes breeding in the pit.
  - i. To reduce water content in the pit ashes or dry cow dung can be added in the help to absorb the water and may reduce odors.

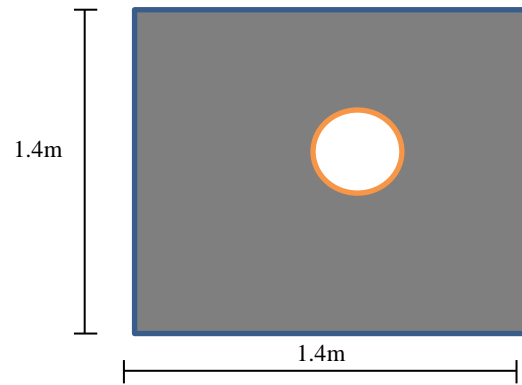

**Simple pit latrine, step 8**

- f. No disinfectant should be added to the pit.
- g. In case of epidemic outbreak the floor should be cleaned daily with disinfectant such as bleach

## Ventilated Improved Pit Latrine (VIP)

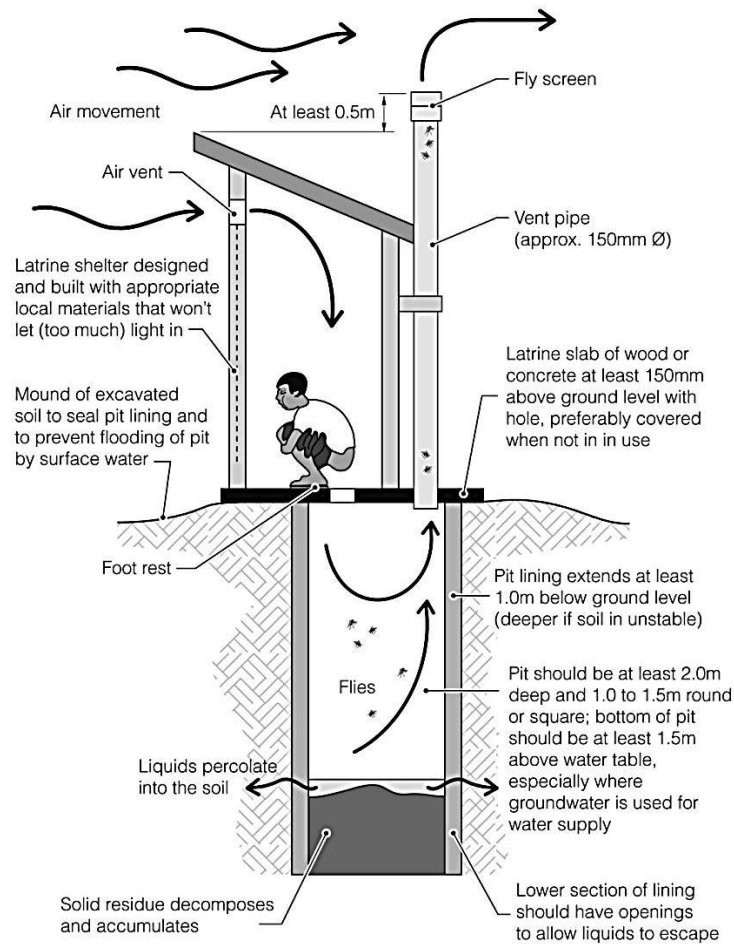

**Ventilated improved pit latrine (Image courtesy of WEDC © Ken Chatterton, 2002)**

Pit latrines can be upgraded to improve hygiene and minimize potential health risks by adding a ventilation pipe. This modification results in a ventilated improved pit latrine, which reduces or eliminates odors problems and flies breeding in the pit.

<b>Basic Information</b>	
Average implementation cost	\$130-395 USD
Average annual maintenance cost	\$7-20 USD
Ease of implementation	Easy
Ease of maintenance	Easy
Efficiency	Flies and odors present, but reduced in comparison to simple pit latrine
Size	Requires 0.06 m <sup>3</sup> of volume per person per year of anticipated use + 0.5 m in depth for covering with soil when full
Lifespan	5-10 years

<b>Advantages</b>	<b>Disadvantages</b>
Low maintenance and implementation costs	Major pathogen runoff
Easy to build	
Readily available materials	
Reduced odors and flies	

<b>Limitations</b>
Must be implemented in an area where the water table is at least 2 m from the bottom of the pit and should not penetrate groundwater
Must be constructed at least 30 m from well
Must be constructed at least 30 m from river
Must be constructed about 6 m from home
Should be constructed downhill from water source
Must be constructed away from

## **Construction**

Same as the simple pit latrine, but with the following changes

1. Squatting slab
  - a. The slab should must have a vent pipe hole (diameter of 0.1m) to allow the installation of the vent
  - b. The ventilation hole can be made halfway between the squatting hole and the edge of the platform

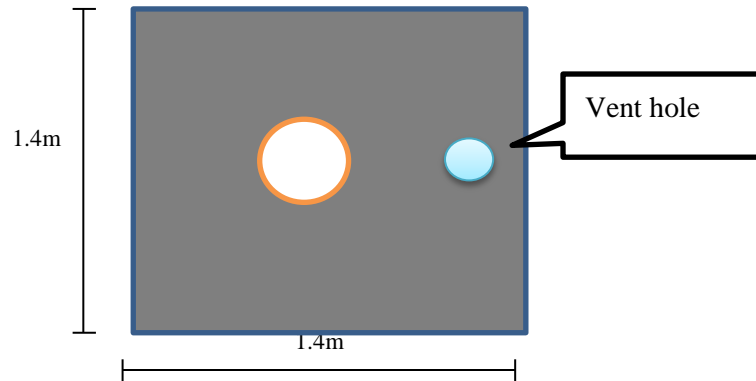

**Ventilated improved pit latrine, Step 1**

2. The vent pipe
  - a. It should have an internal diameter of 0.1 m
  - b. It should have a fly screen on the top opening
    - i. Metal screens tends to deteriorate because of the gases coming up the pipe
    - ii. PVC- coated glass fiber mesh can be used but it will not last more than 5 year
  - c. It should be dark colored and have thin walls
    - i. Suitable examples: black painted PVC or fiber cement
  - d. It can consist of a brick chimney (internal diameter should be no less than 0.225m)



## Pour- Flush Latrine

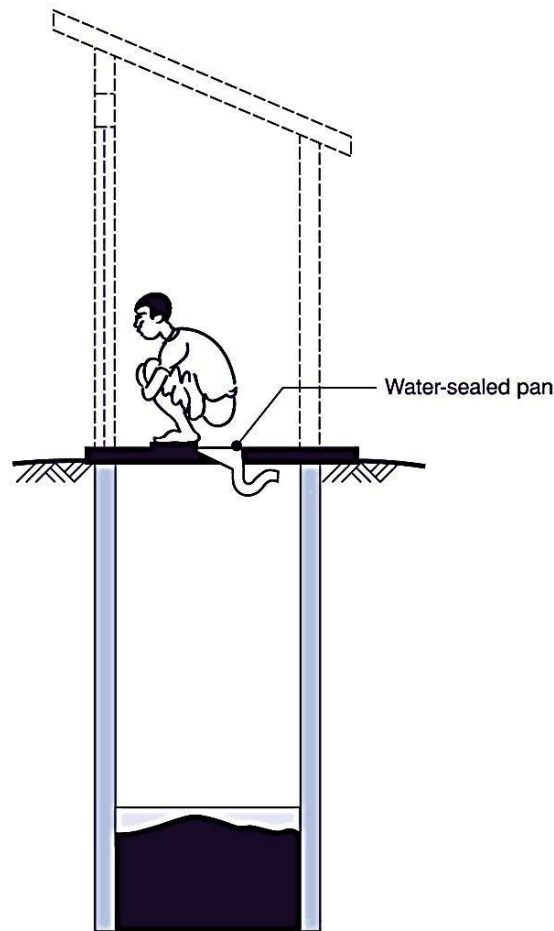

**A basic pour-flush latrine (Image courtesy of WEDC © Rod Shaw, 2002)**

A pour-flush latrine differs from a simple pit latrine because it has a water-sealed pan instead of a hole in the slab. The water in the pan blocks odors from entering the shelter from the pit. It functions by adding a 2-3 L of water after each use to flush the excreta from the pan into the pit. A pour-flush latrine is suitable for areas where water is abundant and readily available. Like a simple pit latrine, a pour-flush latrine will fill up and a new pit must be excavated. However, pour-flush latrines can be built as permanent structures, if the sludge is removed when the pit is at capacity. The possibility of removing the sludge depends on the pour flush latrine design.

<b>Basic Information</b>	
Average implementation cost	\$65-130 USD
Average annual maintenance cost	\$7-13 USD
Ease of implementation	Easy
Ease of maintenance	Easy
Efficiency	No odors or flies, waste is not treated
Size	Requires 0.06 m <sup>3</sup> of volume per person per year of anticipated use + 0.5 m in depth for covering with soil when full
Lifespan	5-10 years

<b>Advantages</b>	<b>Disadvantages</b>
Low maintenance	More expensive than a pit latrine
Easy to build	Cleansing material may cause blockage in the pan
Readily available materials	Requires a constant water source
No odor problem or presence of flies	May require education in order to be used properly

<b>Limitations</b>
Must be implemented in an area where the water table is at least 2 m from the bottom of the pit and should not penetrate groundwater
Must be constructed at least 30 m from well
Must be constructed at least 30 m from river
Must be constructed about 6 m from home
Should be constructed downhill from water source

## **Construction**

Same as the simple pit latrine, but with the following changes

1. The slab (Step 5 in simple pit latrine)
  - a. The pan must be cast in the slab
  - b. An inspection hole must be created in the slab so the level of excreta in the pit can be monitored
  - c. The inspection hole should be no more 0.25m in diameter

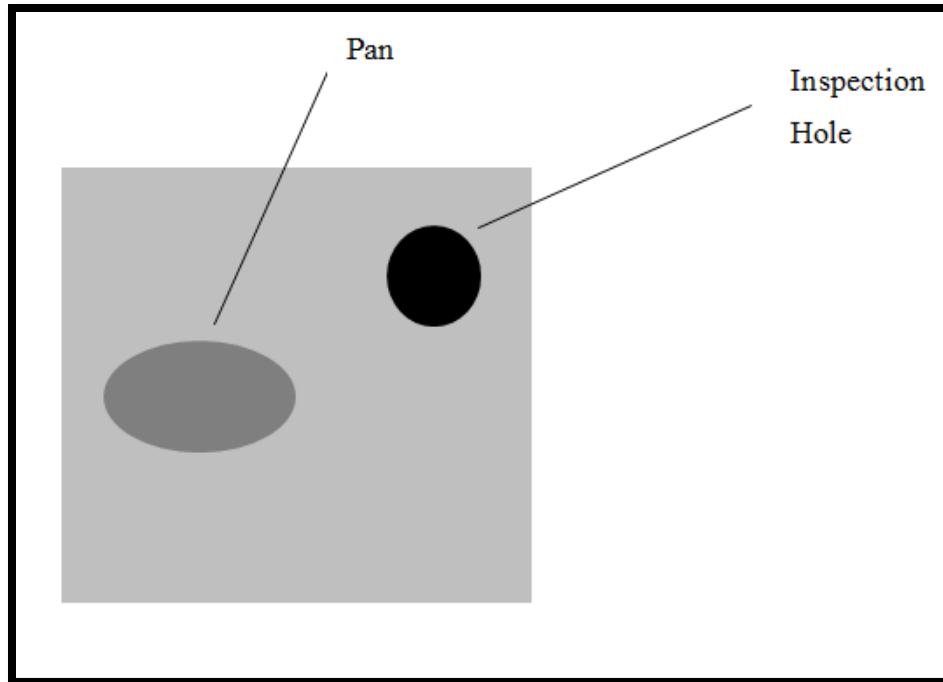

Inspection hole

2. The pan (step 5 in simple pit latrine)
  - a. The pan can be purchased in a home improvement store (EPA) as ceramic or PVC unit (preferred)
  - b. The water pan must be 0.25 m below the slab

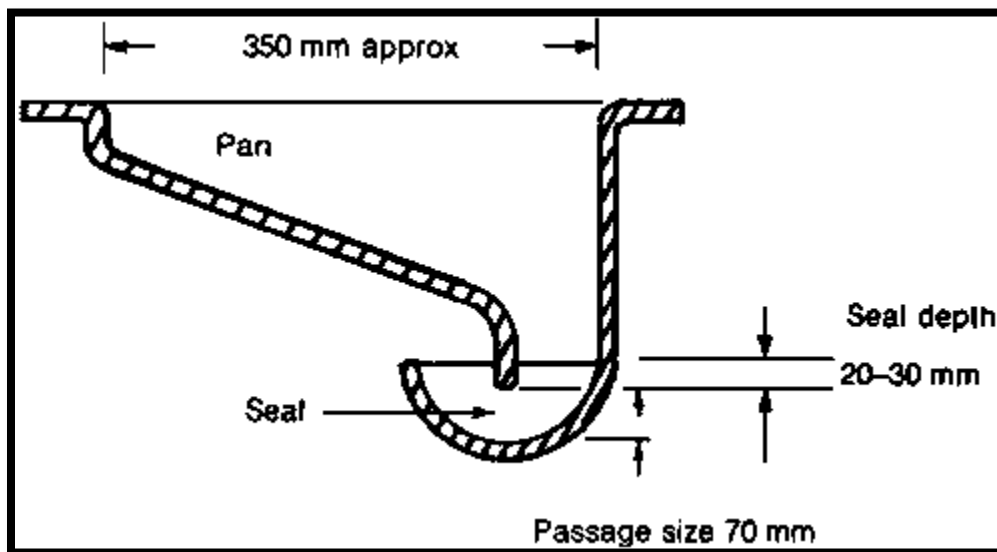

Water pan (Image by WHO, 1992)

3. Maintenance (step 8 in simple pit latrine)
  - a. See pit latrine
  - b. Water should be kept inside the latrine for flushing
  - c. The level of the pit content should be checked monthly
  - d. If the pit is temporary, it should be covered when the excreta level reaches 0.5m from the ground surface
  - e. Paper products should be collected separately from the human waste to avoid clogging the water pan

## Composting Latrine

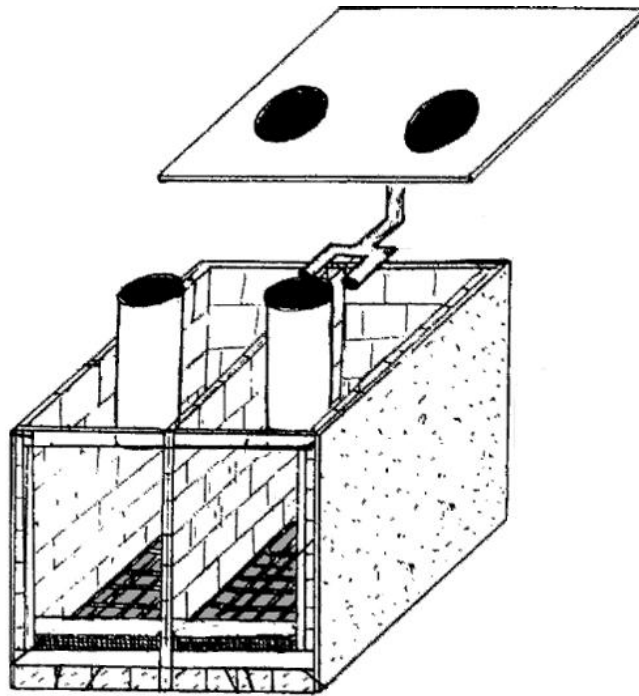

**Composting latrine (Image by Clivus Multrum, Inc., 1994)**

A composting latrine is a dry toilet that operates without the addition of water for flushing. It is best suited for areas that have limited amounts of water or where the water table is far from the ground surface. Organic waste can and should be added to help the excreta break down in the composting latrine. After each use, dry litter such as ash or sawdust is added to help reduce odors and absorb the water content of the excreta. When the first vault is full, it is covered for at least two years and the second vault is used. A composting latrine usually consists of two vaults, with only one is used at a time. When the first vault is full, it is covered and the second vault is used. While the second is in use, the excreta in the first vault decompose and the pathogens die, creating compost. The compost from the first vault can be used as a fertilizer and a soil conditioner. Grey water cannot be disposed of into the composting latrine: if water is present, the composting excreta will spoil, causing odor problems and preventing proper decomposition. There is no need to build a new composting latrine because the compost is removed. A composting latrine is more expensive and more difficult to build compared to a pit latrine or a pour flush latrine, but can be built as permanent structure. Composting latrines

require maintenance to ensure that they work properly (Wolfgang, Berger 2010; World Health Organization, 2005).

<b>Basic Information</b>	
Average implementation cost	\$200- \$460 USD
Average annual maintenance cost	\$7-\$20 USD
Ease of implementation	Medium
Ease of maintenance	Easy
Efficiency	Flies and odors not present if system is kept dry, sludge is sanitized if left in the composting pit for over two years
Size	Approximately 6 m <sup>2</sup> in area, 1 m in depth, and 2 m in height
Lifespan	10-20 years

<b>Advantages</b>	<b>Disadvantages</b>
Does not require water input (therefore reduces water consumption)	Requires separate grey water disposal system
Waste does not require further treatment	Odors and flies if not properly maintained
Can be used to dispose of organic waste (therefore reduces volume of solid waste)	Requires human-excreta contact in order to clean out latrine if compost is not mature
Permanent structure	
Requires daily maintenance	

<b>Limitations</b>
Only appropriate in communities where compost is a useable resource
Must be implemented in an area where the water table is at least 2 m from the bottom of the pit during the wet season and should not penetrate groundwater
Must be constructed at least 30 m from well
Must be constructed at least 30 m from river
Must be constructed about 5 m from home
Should be constructed downhill from water source

## **Construction**

1. Dig a pit 2.4 m long, 2.0 m wide and 0.5-1.0 m deep, with area for a vent pipe
  - a. A small area for a vent pipe must be built off the long side of the pit, 0.25 m by 0.25 m
  - b. No water can be in the pit

- c. If groundwater is close to the surface of the soil, this pit can be constructed out of concrete or other watertight materials above ground. In this case, a watertight floor must also be built in the pit.
- d. Concrete floor must be 50-70 mm thick

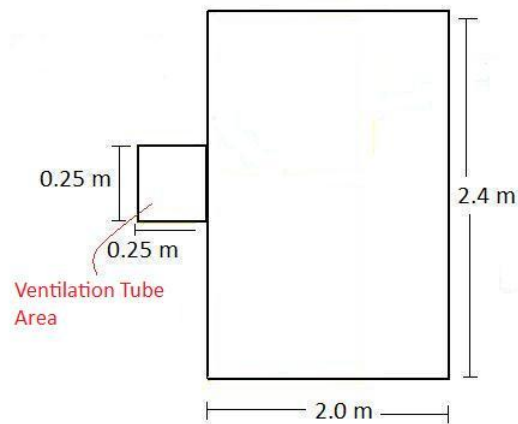

### Composting latrine, step 1

2. Build a dividing wall and line the pit
  - a. A dividing wall must be build 1.2m along the long side of the pit
  - b. Pit lining and dividing wall be constructed with concrete blocks or fired bricks, mortared with cement, and rise 0.8 m from the surface of the ground (making the pit 1.3 m-1.8 m deep)
  - c. Line all sides of the walls and the vent pipe
  - d. The amount of materials needed to line the pit depends on the size of the pit
    - i. For a pit 2.4 m long, 2.0 m wide and 1.6 m deep, with a 0.25m by 0.25 m vent pipe area, without a cement floor, with a dividing wall,  $m^2$  of lining materials is required:
    - ii.  $2(2.4 m \times 1.6) + 3(2.0 m \times 1.6m) + 3(0.25 m \times 1.6m) = m^2$

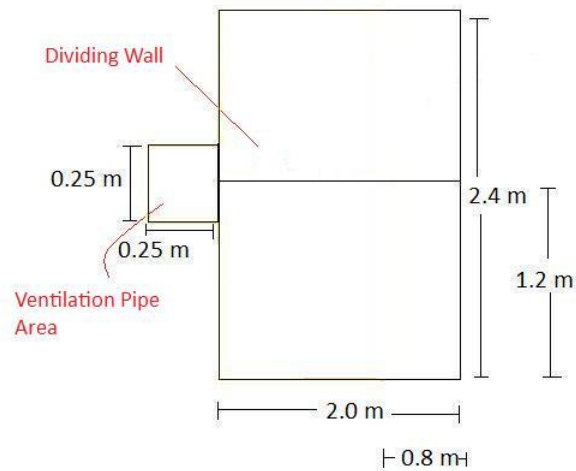

### Composting latrine, step 2

#### 3. Support Beam

- a. Build a support beam from treated timber that is 0.8 m from the side without the vent pipe. It should go across the dividing wall, parallel to the long side of the pit.

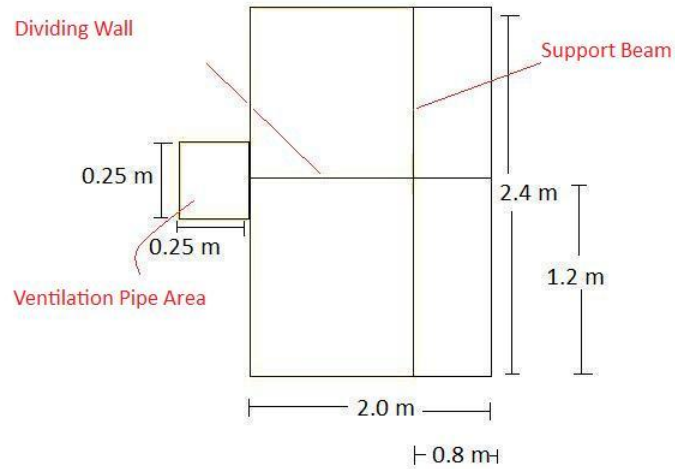

### Composting latrine, step 3

#### 4. Support for slab

- a. Build up walls around the vent pipe area, the large area, and the dividing wall inside the large area with 0.15 m of lining materials (concrete or brick). Do not



add any height to the wall between the vent pipe area and pit to allow for ventilation.

- b. Squatting slabs will be placed over this built up area. The lower portion is for emptying and viewing the pit.

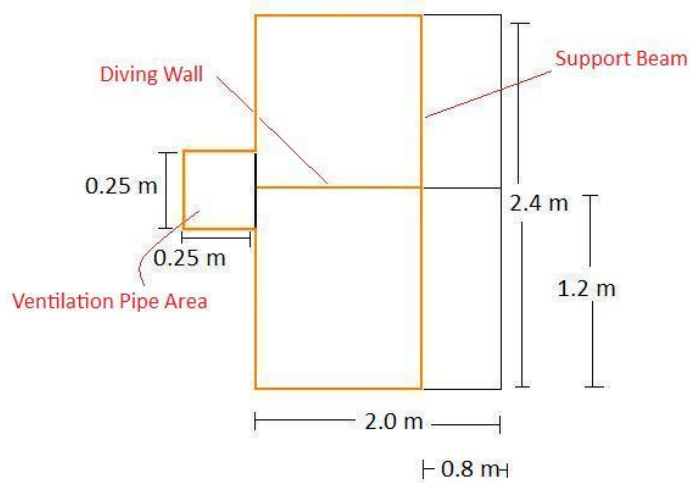

#### Composting latrine, step 4

##### 5. Squatting slab

- a. See simple pit latrine
- b. The squatting slab for composting toilet must cover both pits and have two holes to allow waste to pass into the pit.
- c. The slab supports the user, covers the pit, and prevents animals from entering the pit. For this reason, the slab must be slightly larger than the pit itself
- d. The slab should be made of concrete
- e. The slab must have a hole that the excrement can pass through into the pit
- f. The slope of the slab should slant toward the hole to allow waste to drain into the hole
- g. The opening should be smaller than 0.25 m in any direction to prevent a child from falling into the pit latrine
- h. The slab can have a seat built on top of the hole for comfort or the user can squat above the hole

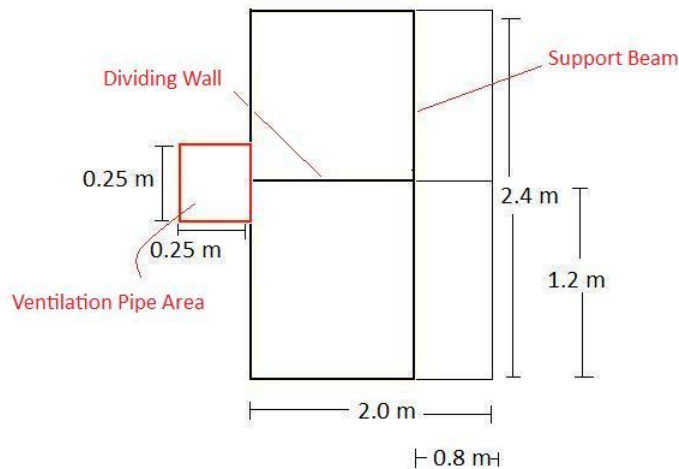

### Composting latrine, step 4

6. Lid
  - a. See simple pit latrine
7. Ventilation Chimney
  - a. The ventilation area should be built up with bricks or concrete blocks until it is as tall as the shelter. The top of the ventilation chimney should be covered with wire mesh to prevent any materials from getting into the pit. A small wooden or tin roof should be added to prevent rain from going down the chimney.
8. Shelter
  - a. See simple pit latrine
9. Maintenance
  - a. See pit latrine
  - b. Organic waste should be added to the latrine weekly, if not daily
    - i. This helps the excreta decompose and results in better compost
  - c. Dry litter, such as sawdust and ash, must be added to the latrine after each use
    - i. This reduces odor and results in better compost
  - d. When the vault is full (0.5 m from the slab), the vault must be sealed, and the other vault must be used. The full vault must remain unused for two years to allow the excreta to decompose.
  - e. After two years, the excreta will contain no pathogens. It should be dry and odorless. It can then be used as fertilizer.

## Composting Latrine with Urine Diversion

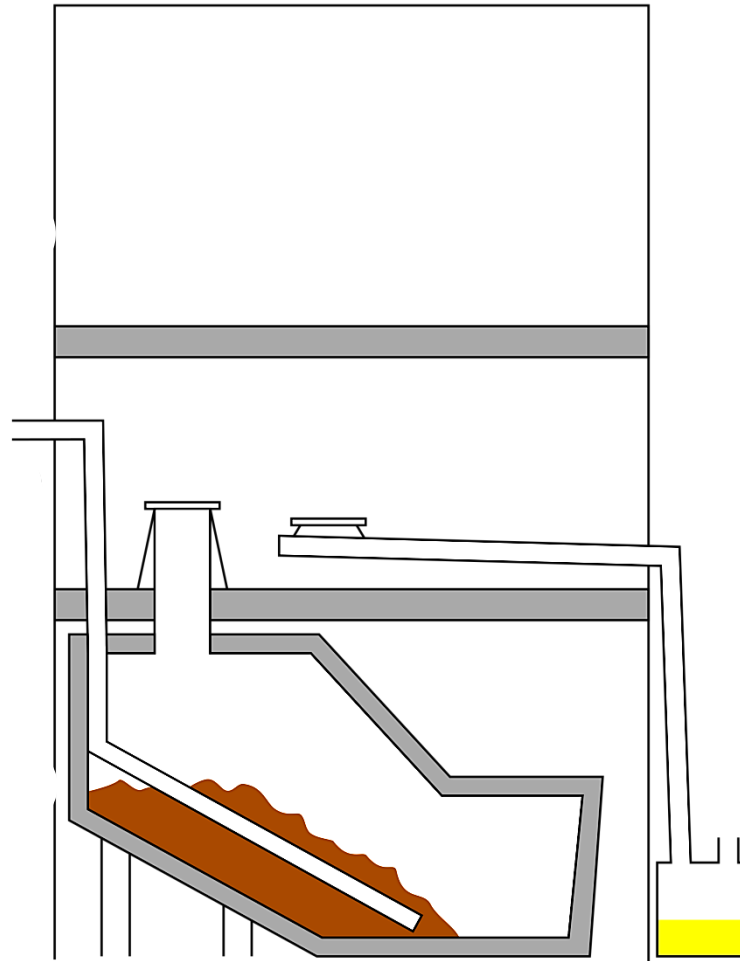

**Composting latrine with urine diversion (Image by Clivus Multrum, Inc., 2010)**

Composting latrines can be upgraded to a composting latrine with urine diversion. Composting latrines with urine diversion are also known as urine diverting dry toilets, or UDDT. The benefit of a urine diverted composting latrine is that it reduces the amount of leachate production, which also means that there is less need to add litter to absorb the water. The composting latrine divides feces from urine into two separate vessels. Composting latrines require maintenance to ensure that they work properly (Wolfgang, Berger 2010).

<b>Basic Information</b>	
Average implementation cost	\$210-\$470 USD
Average annual maintenance cost	\$7-\$20 USD
Ease of implementation	Medium
Ease of maintenance	Easy
Efficiency	Flies and odors not present if system is kept dry, sludge is sanitized if left in the composting pit for over two years
Size	Approximately 6 m <sup>2</sup> in area, 1 m in depth, and 2 m in height
Lifespan	10-20 years

<b>Advantages</b>	<b>Disadvantages</b>
Does not require water input (therefore reduces water consumption)	Requires separate grey water disposal system
Waste does not require any further treatment	Odors and flies if not properly maintained
Can be used to dispose of organic waste (therefore reduces volume of solid waste)	Requires human-excreta contact in order to clean out latrine if compost is not mature
Permanent structure	May be challenging for children and elders to use
Requires daily maintenance	
Because there is less liquid input than standard composting toilets, waste decomposes faster and a higher quality compost is produced	

<b>Limitations</b>
Only appropriate in communities where compost is a useable resource
Must be implemented in an area where the water table is at least 2 m from the bottom of the pit during the wet season and should not penetrate groundwater
Must be constructed at least 30 m from well
Must be constructed at least 30 m from river
Must be constructed about 5 m from home
Should be constructed downhill from water source

## **Construction**

Follow composting latrine with the following modifications in Step 8:

1. The urine is diverted from inside the latrine into a container outside the latrine

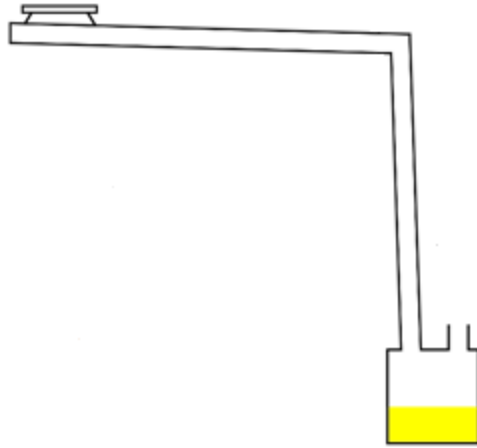

### **Composting latrine with urine diversion, step 1**

2. A pan made of PVC can be installed on a wooden box. This pan will be connected by PVC pipe through the wall of the shelter into a container outside the latrine.
3. The urine must be disposed of daily. A mixture of 1 part urine, 3 parts water can be used to water plants.

## Septic System

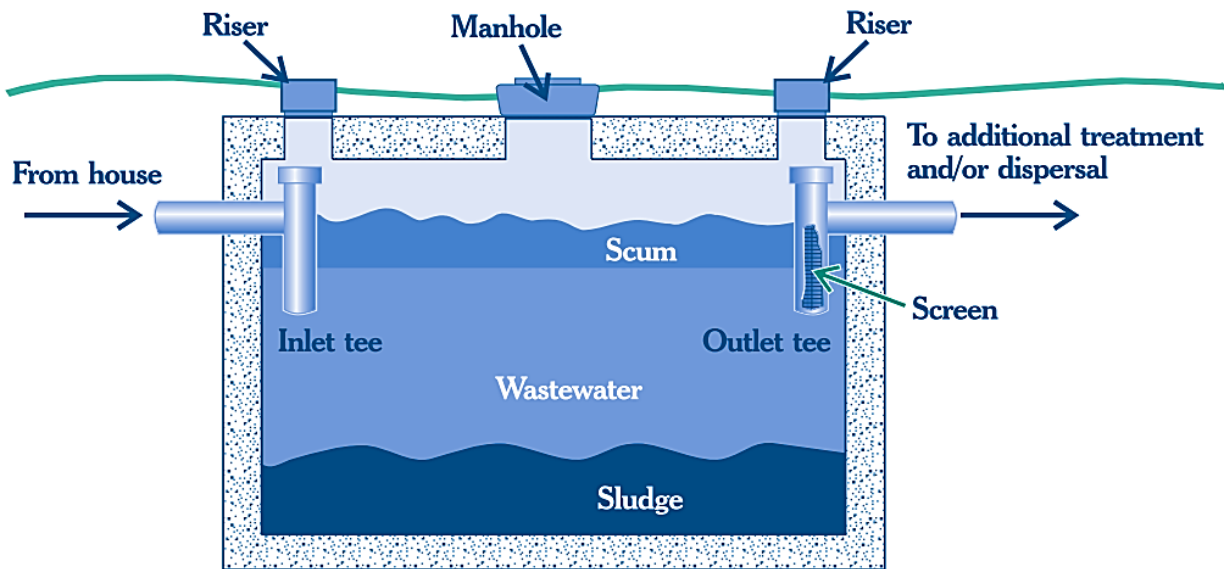

Single chamber septic tank diagram (US EPA, 2002)

A septic system is an on-site human wastewater management option that consists of a pipe from the residence, a septic tank, a drainage field, and soil. All wastewater is transported from the residence to the septic tank by a pipe. A septic tank is a large container in which sewage is collected and decomposed by anaerobic bacteria. It is watertight and typically underground. Solid waste particles settle to the bottom of the septic tank, referred to as sludge, and grease and oil rise to the top of the tank, also known as scum. The effluent can be pumped from the septic tank into the drainage field, where it is then treated by the soil through percolation. However, the effluent is only partially treated and pathogens remain. Septic tanks require routine removal of the sludge and scum, generally every two to five years. If the sludge and scum are not removed, overflow can occur and flood the property with raw sewage. Overflow is very expensive to clean and can result in adverse health effects, such as hepatitis. Due to the risk of overflow, annual monitoring is required. A micro-septic tank operates the same way as a normal septic tank, but is much smaller and can hold less wastewater. For this reason, it is only meant to treat black water. It must be emptied every one to two years. All types of septic tanks require an expert for sizing and construction (Frenoux, 2011; US EPA, 2002).

<b>Basic Information</b>	
Average implementation cost	\$500-\$1000 USD
Average annual maintenance cost	\$7-13 USD
Ease of implementation	Difficult
Ease of maintenance	Easy
Efficiency	No flies or odors present, partially treats wastewater
Size	At least 5m <sup>2</sup> of available space for tank, about 30 m <sup>2</sup> for drainage field
Lifespan	10-20 years

<b>Advantages</b>	<b>Disadvantages</b>
Low operating costs	Requires regular emptying by a professional
Treats both black water and grey water	High investment cost
	Effluent requires secondary treatment
	Requires a constant source of water
	Requires a large area of land for drainage field

<b>Limitations</b>
Must be implemented in an area in which a professional septic tank emptying service is available
Must be implemented in a community that is not at risk of flooding
Must be implemented in a community that has methods for further treating effluent or transporting effluent off-site to be treated
Must be constructed at least 30 m from water source
Should be constructed downhill from water source

## Construction

The following instructions are for the construction of a two-chamber septic tank. The individuals constructing the system should be skilled in working with concrete. A professional should be consulted. Improper installation of a septic tank can result in untreated sewage seeping into the soil, causing odors and groundwater contamination.

1. Calculate required volume
  - a. The volume of the tank must be 3 times the volume of wastewater the household can produce
  - b. The volume of the tank should be 1.5 m<sup>3</sup> with 0.3 m clearance above wastewater level to accommodate minimal overflow

2. Building the tank

- a. The tank should be dug out of the ground: 1.5 m long, 1.5 m wide, and 1.8 m deep

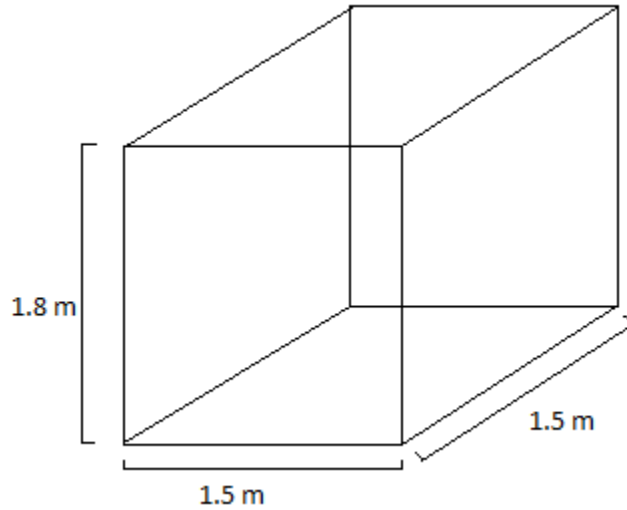

**Septic system, step 2a**

- b. A dividing wall should be built so that  $\frac{2}{3}$  of the total volume is on one side of the wall, and the remaining  $\frac{1}{3}$  on the other
- i. This wall should be constructed 0.5 m along either the side of the pit



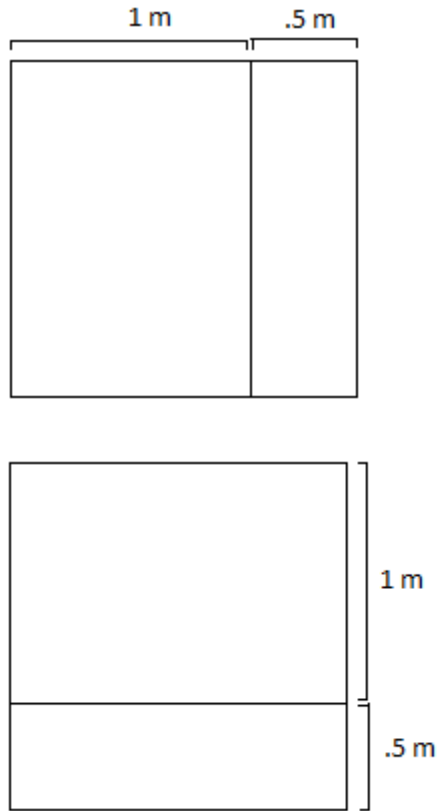

**Septic system, step 2b**

- ii. It must be constructed of concrete or brick
- iii. There must be a pipe between the two chambers. This allows effluent to pass from the large chamber into the small chamber. The hole should be at the center of the dividing wall.
- c. There must be two T-shaped pipes leading to and out of the tank. They are T-shaped to prevent scum and sludge from blocking the wastewater flows. The pipes allow wastewater to flow into the tank and effluent to flow out of the tank. These pipes are usually 0.1 m in diameter and made of PVC.
  - i. One pipe carries wastewater from the residence into the septic tank. The other carries effluent from the tank into a drainage field.

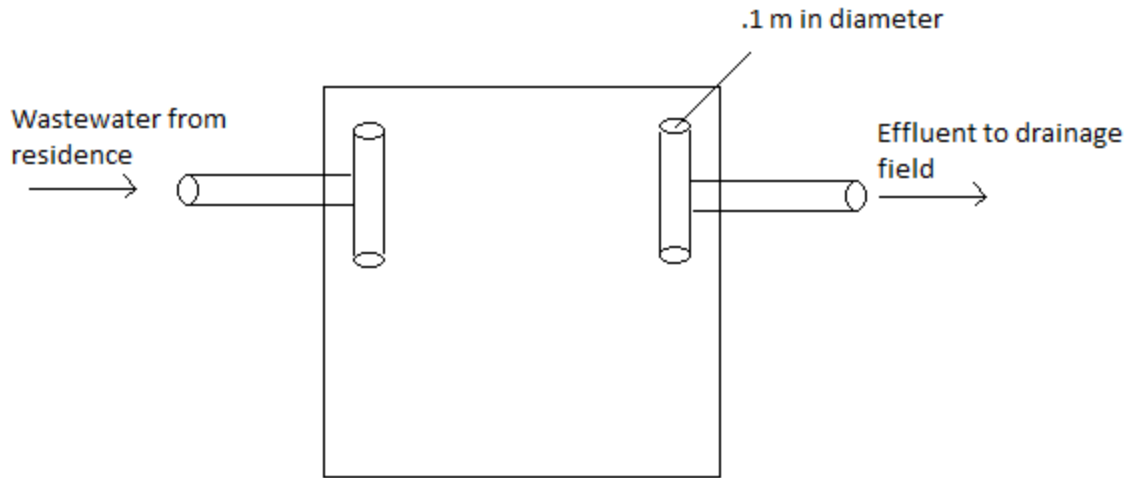

**Septic system, step 2c**

- d. All walls should be lined with concrete or bricks. They should be watertight, including the area around each pipe. This can be achieved using cement mortar.

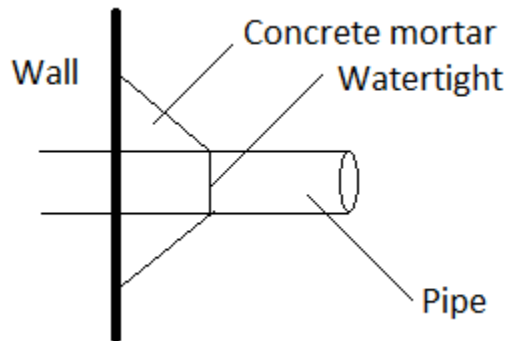

**Septic system, step 2d**

- e. A lid made out of concrete should cover the entire tank, with an inspection hole with a cover over the small chamber. There should also be a ventilator above the large chamber to allow gas to escape the tank. This can be made of PVC pipe with a screen over it to prevent insects from entering the pit and a small roof to prevent rain from entering the pit. The PVC pipe should be 0.05 m in diameter.

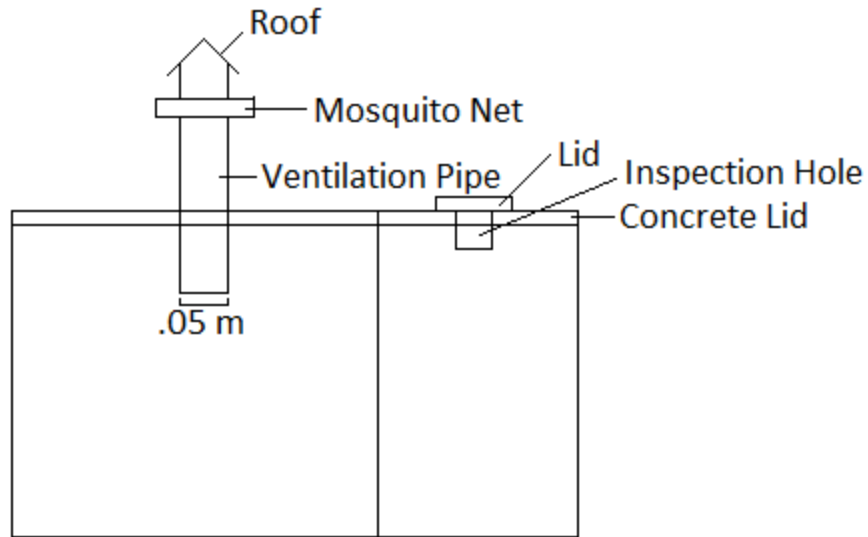

Septic system, step 2e

3. Effluent disposal

- a. Sludge will sink to the bottom of the tank and scum will float to the top. The remaining effluent is then pumped into a drainage field or dry well.

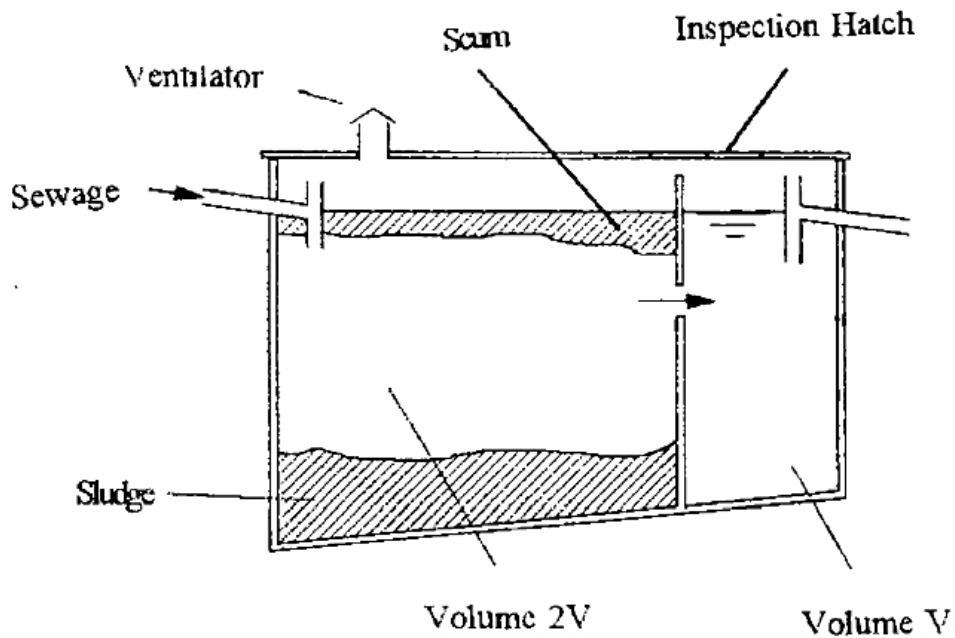

Two-chambered septic tank (WHO, 2005)

- b. Construct a Percolation Trench to dispose of the effluent: See Percolation Trench
- 4. Maintenance
  - a. A septic tank needs to be inspected at least once a year to see if it is full. Every three to five years, it must be emptied of sludge. This must be done by a professional septic cleaning company with a suction pump and tanker.

## Constructed Wetland

Constructed wetlands, also referred to as reed beds, biogardens and waste stabilization ponds, allow water to flow through vegetation slowly, filtering out suspended solids. Microorganisms that live in wetlands degrade other pollutants in the water, such as nitrogen and phosphorus. Plants used are indigenous to the location in which the wetland is constructed. Grey water and pretreated black water, such as septic tank effluent, can be treated by constructed wetlands (DuPoldt, 1994; US EPA, 2004). Constructed wetlands consists of a filter to trap large particles, a grease trap to eliminate oils, an anaerobic pond over 2.5m deep to remove solids and organic matter, an optional pond between 1-2 m deep to remove pathogens, and a maturation pond between 1- 2m deep to complete the treatment. Constructed wetlands are less expensive to build than other wastewater treatment options and tolerate fluctuations in volume of wastewater. A constructed wetland allows water to flow above or below the surface of the channel. There are two types of constructed wetlands: surface flow, where wastewater flows on top of the soil in the channel, and subsurface flow, where wastewater flows through a porous medium, such as gravel, in the channel. The channel is lined with clay or synthetic lining and covered with stones and earth. Native aquatic vegetation is then planted in the channel. Wastewater is poured into the channel and the constructed wetland filters out solids and removes organic impurities, such as nitrogen and phosphorus.

<b>Basic Information</b>	
Average implementation cost	\$35-\$80 USD
Average annual maintenance cost	\$3-\$5 USD
Ease of implementation	Medium-Difficult
Ease of maintenance	Easy
Efficiency	No flies or odors, treats wastewater
Size	1 m <sup>2</sup> per person, deepest pond is 2.5 m deep
Lifespan	25-50 years

<b>Advantages</b>	<b>Disadvantages</b>
Low operating costs	Sludge requires secondary treatment
Treats both pretreated black water and grey water	High investment cost
Efficient at removing pathogens	Long start up time
Tolerates fluctuations in volume of wastewater	Requires a large area of land
Aesthetically pleasing, provides animal support by habitat	Requires regular maintenance of plants
Porous material may be created from recycled materials (i.e. tire chips)	Requires weekly monitoring to determine when the wetland or grease trap must be cleared of material
	May facilitate mosquito breeding

<b>Limitations</b>
Must be constructed at least 30 m from home
Must implement a secondary treatment option for the sludge that collects in the wetland
Must implement in an area that floods less frequently than once every 100 years

## **Construction**

Constructed wetland design and planning should be done by a professional. Wetland placement is dependent on the specific area in which it will be constructed. It is crucial that wetlands are designed properly because uneven water flow renders the wetland useless. Construction can be done by community members. However, it cannot be completed manually. It requires the use of a backhoe.

### 1. Selecting soil

- a. Soil pH should be between 6.5 and 8.5: pH affects the ability of the soil to retain waste.
- b. Sand should be avoided because of the lack of nutrients for the plants, and clay should not be used because it inhibits plant growth. Loam is the best option for use in a constructed wetland. Loam is about 40% sand, 40% silt, and 20% clay.
- c. The soil must contain organic matter in order for the aquatic plants to flourish in the wetland. This can be achieved by adding compost or sewage sludge to the soil. Sand can be used if it is supplemented with organic matter.

## 2. Selecting plants

- a. Ideal plants for constructed wetlands are bulrushes, spikerush, sedges, rushes, reeds, and cattails. Not all species that are present in naturally occurring wetlands are appropriate for constructed wetlands because of the exposure to wastewater.
  - i. These are of the genera *Scripus*, *Efeocharis*, *Cyperus*, *Juncus*, *Phragmites*, and *Typha*.
- b. Native species should be used because they have adapted to local climate and pests
- c. Bulrush (*Scripus*) is often the best choice because it is non-invasive, fast growing, and tolerating of materials in wastewater
- d. Plants should be fully grown before they are used to treat waste
- e. The wetland should include a variety of plants and should be densely planted

## 3. Choosing a site

- a. The site should not be in an area that floods more than once in 100 years
- b. Selection of a constructed wetland site should be conducted by a professional certified in wetland allocation
- c. Wetland should be constructed on a level area of land

## 4. Sizing the Wetland

- a. The size of the wetland depends on the number of individuals reliant on the system, the volume of waste those individuals produce, the amount of treatment required for pollutant elimination, and the percolation rate of the soil
- b. The length to width ratio should be between 1:1 and 10:1

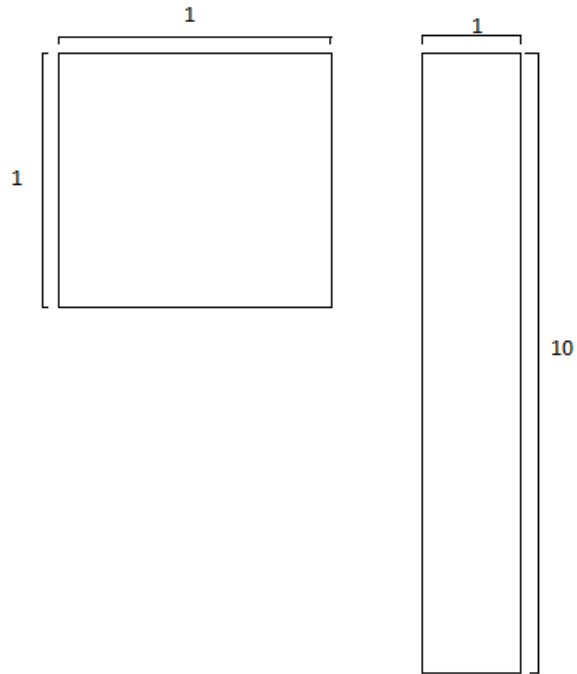

**Constructed wetland, step 4b**

- c. The maturation pond requires  $1 \text{ m}^2$  per resident.
  - i. For a community with 200 inhabitants, a  $200 \text{ m}^2$  maturation pond
- d. The size of the anaerobic pond depends on the size of the maturation pond. It should be 1%-5% of the size of the maturation pond. For example, a  $200 \text{ m}^2$  maturation pond warrants an anaerobic pond that is 2-10  $\text{m}^2$ .



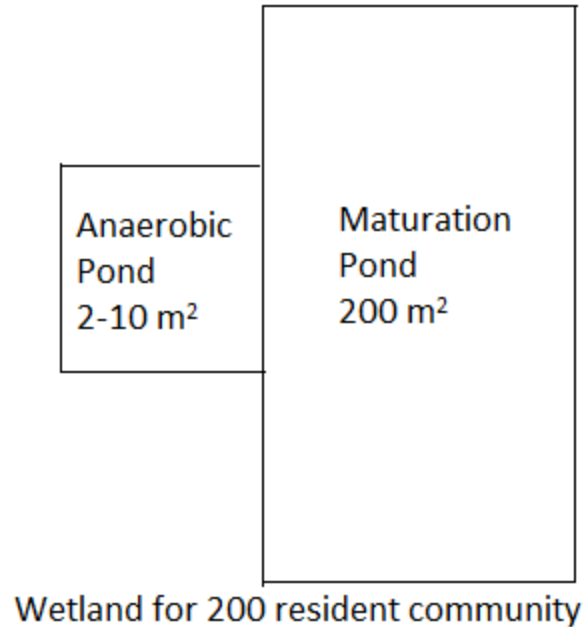

**Constructed wetland example, step 4d**

5. Constructing berms

- a. Berms prevent water from entering or exiting the wetland
- b. They are generally built 0.6-1 m above the water level in the wetland with slopes of 35°-55°. They should be as high as necessary to prevent storm water runoff from entering the wetland



**Constructed wetland, step 5**

6. Grease trap

- a. A grease trap should be installed to prevent grease, oil, and fat from entering the constructed wetland

- b. A grease trap can be created from a 55-gallon barrel. Grey water from the home is deposited into the tank at the top. Grease floats to the top and the remainder of the grey water leaves the tank from a hole in the bottom
- c. Grease can be removed from effluent from septic tanks in the same manner
- d. Grease, oil, and fat must be skimmed off the top of the barrel weekly

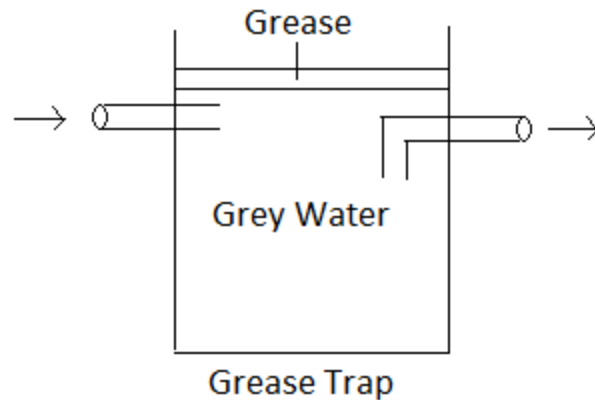

**Constructed wetland, step 6**

**7. Building the Constructed Wetland**

- a. Excavate the area for the anaerobic pond, as determined in Step 4
- b. Line the pit with clay or synthetic liner, such as a 30 mil PVC liner
- c. Excavate a ditch from the wastewater source to the anaerobic pond for the inlet pipe that slightly declines toward the pond to allow for wastewater to flow by gravity



**Constructed wetland, step 7c**

- d. Lay the inlet pipe, made of PVC, in the ditch and cover with soil

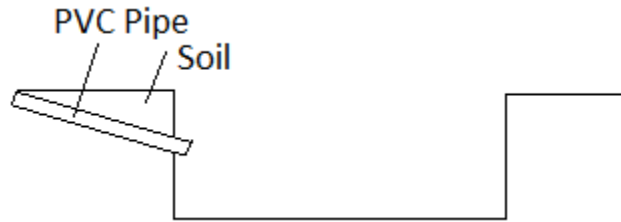

**Constructed wetland, step 7d**

- e. Fill the pit with gravel, fill with soil and level it
- f. Dig a ditch from the anaerobic pond to the maturation pond or percolation trench (see Percolation Trench) and lay the PVC outlet pipe into the ditch and cover with soil

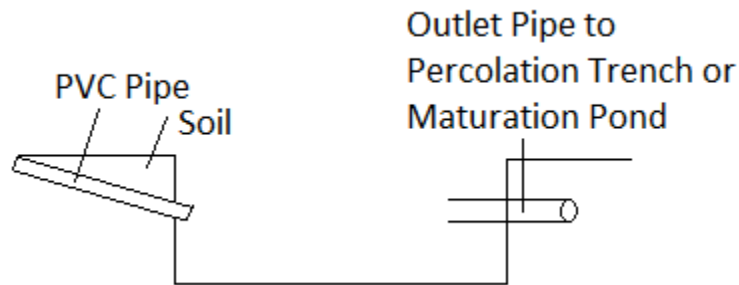

**Constructed wetland, step 7f**

- g. Test wetland by filling it with clean water, checking for leaks and that the system flows properly
  - h. Add aquatic plants
8. Maintenance
- a. Maintenance varies slightly depending on the calculated size of the wetland and the composition of the wastewater

- b. Inlet and outlet pipes must be cleaned occasionally to remove any debris
- c. Water level should be constant. Changes in water level may be due to leaks in the lining, clogged pipes, or breached berms
- d. Constructed wetlands do not require maintenance concerning vegetation, unless the plants grow too sparsely. In that case, vegetation must be replanted
- e. Mosquito predators, such as mosquito fish and dragonflies, should be added to the wetland if mosquito breeding becomes a problem

## Dry Well

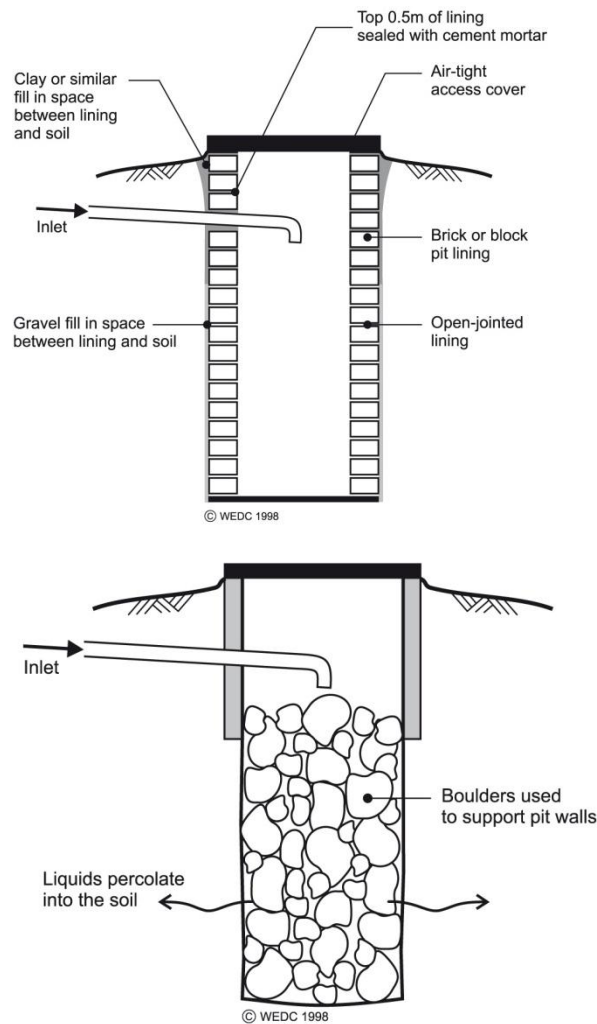

**Dry wells (Images courtesy of WEDC © Rod Shaw, 2002)**

A dry well, also known as a soak pit or soakaway, consists of a pit filled with gravel or a pit that is lined with porous material that permits wastewater to seep into the soil. It is best suited for an area where the soil allows water to infiltrate easily. Dry wells are only used for grey water or pretreated effluent. The pit must be located above the water table so it remains dry. Wastewater is directly discharged into this pit, where it percolates through the gravel and soil. Disposing of grey water into a dry well is useful in reducing the volume of excess wastewater on land or in surface water. Dry wells must be cleaned out if they are clogged by materials such as grease and soap. A grease trap can also be implemented to reduce the frequency of cleaning (Frenoux, 2011).

<b>Basic Information</b>	
Average implementation cost	\$40-\$80 USD
Average annual maintenance cost	\$7-\$14 USD
Ease of implementation	Easy
Ease of maintenance	Easy
Efficiency	No flies or odors
Size	1 m in diameter and 2.5 m deep
Lifespan	3-5 years

<b>Advantages</b>	<b>Disadvantages</b>
Low cost of maintenance and operation	Clogging can occur
Easy to build	Not appropriate in cold climates
Readily available materials	Pre-treatment of the black water is required
Requires small areas for construction	May contaminate groundwater
Replenishes groundwater bodies	
User friendly	

<b>Limitations</b>
Soil must be permeable
Must not be built in area with risk for flooding
Must be built at least 30 m from any water source
Bottom of pit must be built at 1.5 m above water table
Should not be used in an area in which high volumes of wastewater are produced daily

## **Construction**

1. The pit:
  - a. The pit should be 1 m in diameter and 2.5 m deep (for one household). Choose part b or part d.

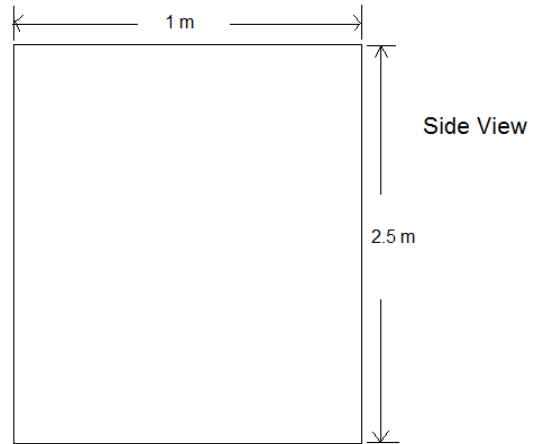

**Dry well, step 1a**

- b. Lay 0.04 m of sand in the bottom and 0.04 m of gravel over the sand. Fill the hole with stone.

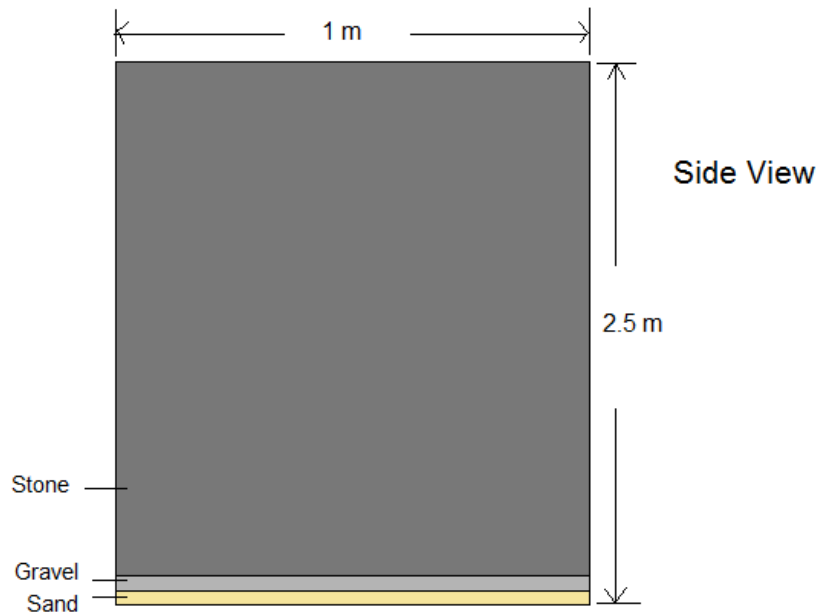

**Dry well, steps 1b & c**

- c. Line the hole with brick.

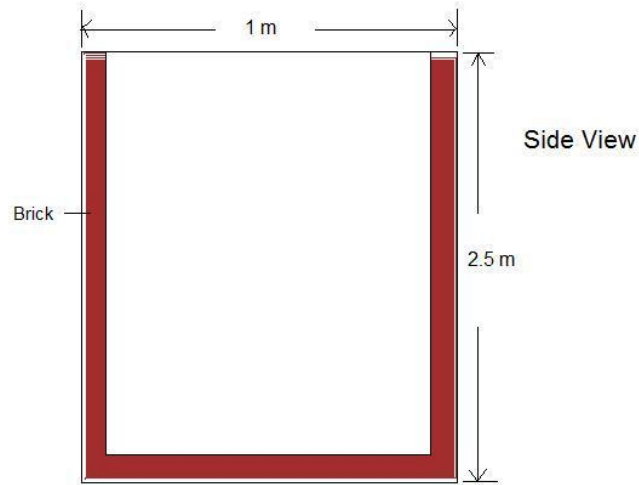

**Dry well, step 1d**

2. The cover

- a. The pit should be covered to prevent:
  - i. The well from caving in
  - ii. Entrance of flies and other vermin into the pit
- b. Ensure that there is an opening in the cover for maintenance.
- c. The cover should be made of concrete or with well-compacted clay or soil

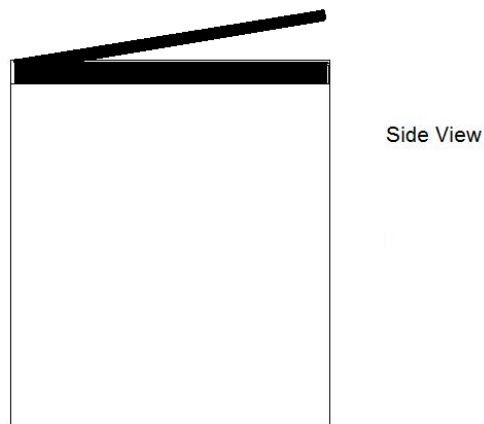

**Dry well, step 2c**



3. The pipe

- a. The inlet pipe should enter the well close to the top
  - i. A PVC pipe 0.1 m in diameter can be used

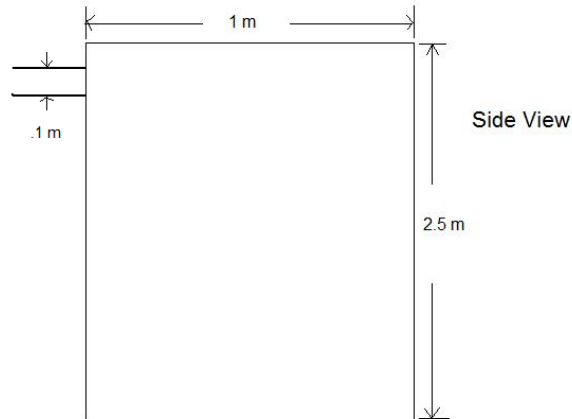

**Dry well, step 3ai**

4. Maintenance

- a. Dry wells can be opened, cleaned out, and refilled with the same rocks
- b. Wastewater should be filtered before entering the dry well to ensure that it doesn't get clogged (i.e. with a grease trap)
- c. The dry well should be kept away from high traffic so the soil around the pit is not compacted
- d. Should be properly cleaned out when sludge accumulates in order to maintain functionality

## Percolation Trench

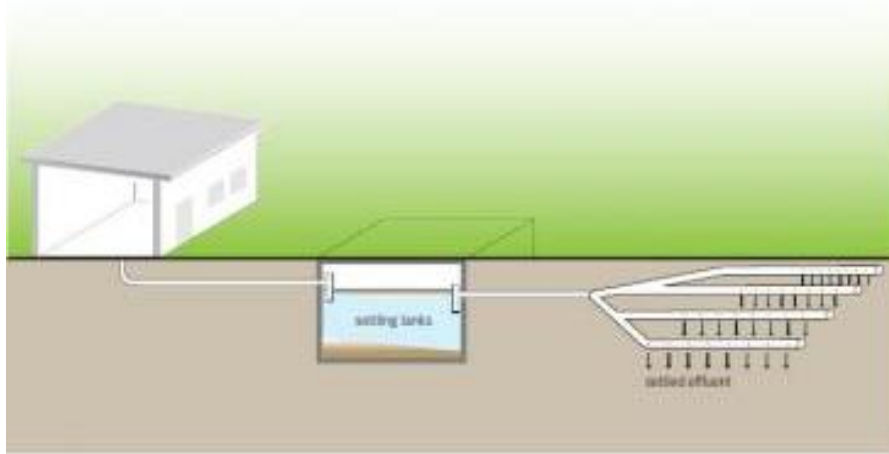

**Leach field (Image by Tilley, 2008)**

Percolation trenches, also known as infiltration trenches, can be used to dispose of grey water or pretreated effluent. Like dry wells, they treat water by percolation. The system consists of a shallow canal filled with gravel. Wastewater percolates through the gravel and the soil at the sides and bottom of the trench. Like dry wells, percolation trenches are not appropriate for areas in which flooding is common. Percolation trenches can be combined with a septic tank.

Wastewater is piped down into the trenches. The trenches have perforated pipes laid on top and are covered with gravel. The trenches are covered with geotextile fabric to prevent the pipe from clogging. The system is ideal for areas where the soil is permeable.

The trenches should be located in an area a high water table and at least 30 m away from a potable water source. The trench should be at least 20 m long and trenches should be at least 1 to 2 m apart. Users should be knowledgeable on how the system functions. There are low health risks because the users are rarely exposed to the effluent.

<b>Basic Information</b>	
Average implementation cost	\$40-\$80 USD
Average annual maintenance cost	\$7-\$14 USD
Ease of implementation	Difficult
Ease of maintenance	Easy
Efficiency	No flies or odors present
Size	20 m <sup>2</sup>
Lifespan	10-20 years

<b>Advantages</b>	<b>Disadvantages</b>
Reduce local flooding	Require frequent inspection and maintenance
Low skills level for maintenance	Risk of clogging by sedimentation
Can be used for combined treatment	Risk of groundwater contamination
Appropriate if there is no intention of reusing grey water	Requires a large area
Replenishes groundwater	Building materials may not be locally available
User friendly/safer than drywells	Requires expert design and construction

<b>Limitations</b>
Soil must allow infiltration
Must be built at least 30 m from any drinking water source
Location must have a low ground level and be open to the sun
Should not be used for high daily volumes of grey water
Trees and deep rooted plants should be kept away from the construction area

## **Construction**

### 1. Constructing Trenches

- a. Each trench must be excavated 0.3-1.5 m deep and 0.3-1 m wide
  - i. Can be excavated manually
- b. The trench should at least be 20 m long and each trench should be about 1-2 m apart
- c. Fill each trench with 0.15 m of gravel
  - i. Gravel with a diameter of 20-50 cm in diameter is preferred
- d. Perforated distribution pipes must be laid on top of gravel
- e. An additional layer of gravel 150 cm thick should be added to cover the pipes
- f. The pipes should be buried 150 cm from the ground surface
- g. A layer of geotextile fabric should be added to prevent clogging of pipe by small particles
- h. The trench should then be covered with soil to ground level

### 2. Perforated pipe

- a. The pipes should be ceramic sewer pipes 0.1 m in diameter

### 3. Distribution box (optional)

- a. Directs the water into the different channels electrically or by gravity

### 4. Maintenance

- a. There is little maintenance required since the system is underground
- b. There should be no plants or trees above the system and no heavy traffic
- c. If clogging occurs (which will happen after a long period of time) the pipes should be cleaned or removed and replaced

## Slow sand Filter

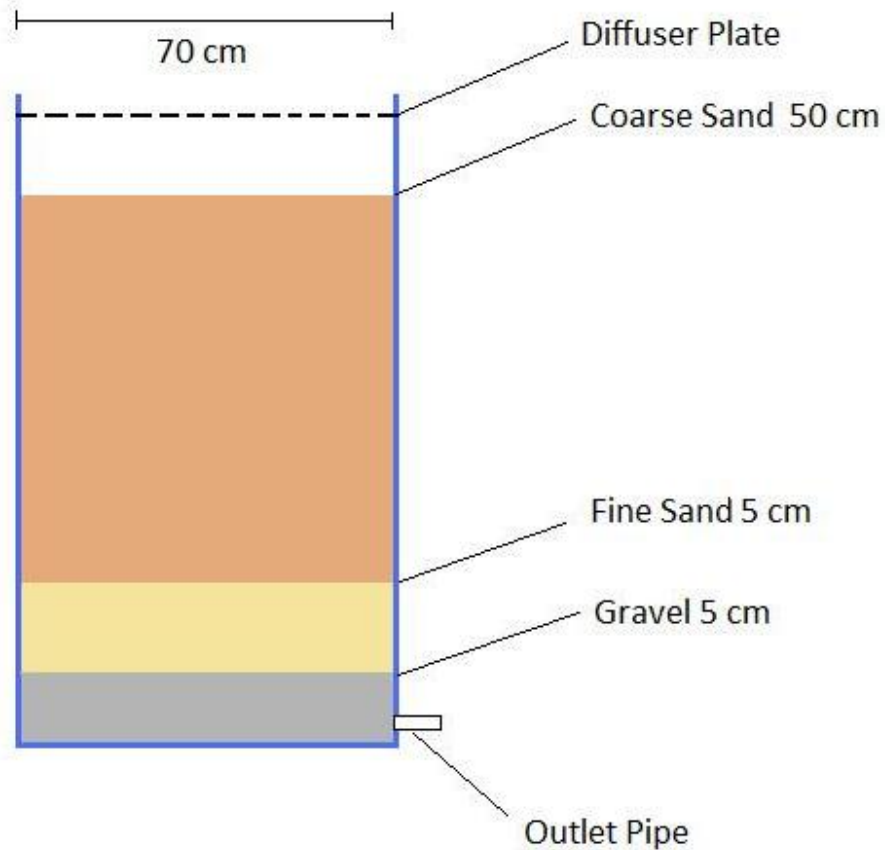

**Sand filter**

Slow sand filters are ideal for areas where grey water can be reused. The basic concept of the system is to filter grey water through layers of granulated materials, such as gravel and sand. Microbes and other particles are removed from the water by the granulated material. The design of the system depends on the user preference. The amount of water should be taken into consideration when building a slow sand filter. Slow sand filters can be purchased or constructed manually. It is recommended that the wastewater to be pre-treated using a grease-trap (see septic tank).

<b>Basic Information</b>	
Average implementation cost	\$125
Average annual maintenance cost	\$0
Ease of implementation	Easy
Ease of maintenance	Easy
Efficiency	High
Size	Varies, this example uses 55- gallon plastic drum
Lifespan	10-20 years

<b>Advantages</b>	<b>Disadvantages</b>
No risk of groundwater contamination	Frequent clogging
Easily built with local materials	Regular maintenance
Variety of materials can be used	Risk of odors problem
High quality of treated water	Pre-treatment is required
Low level of skills required for construction and operation	
Treated water can be reused	

<b>Limitations</b>
Cannot be used to treat black water
Should not be used for high daily volumes of grey water

## Construction

There are many different designs that can be used. The most important components of a sand filter is a container that has an inlet at the top and outlet at the bottom, a layer of sand, a layer of fine gravel, and a layer of coarse gravel. It should also have a diffuser plate that gently and evenly distributes water over the top of the sand.

1. Container and pipe
  - a. Watertight container
    - i. 250 L plastic drum should be used
    - ii. Must have a clean interior before the gravel and granular material is added
    - iii. Drill an outlet hole at the bottom of the container, 2 cm from the base
      1. The hole needs to be one inch (2.54 cm) in diameter
2. Pipe
  - a. The pipe can be made out of PVC that is one inch (2.54 cm) in diameter

- b. Attach a nipple-elbow socket pipe to the drum by screwing it to the drum at the bottom of the container and connecting to the PVC
  - c. A small mosquito mesh must be placed over the outlet hole inside the drum so that no gravel pieces travel through the outlet pipe and block the opening
  - d. The sand filter must be raised by concrete blocks or wood to allow for a collection bin to collect water from the outlet pipe
3. Filter media
- a. Wash the sand before placing it in the container
    - i. It can be washed by filling the container with sand and then with clean water
    - ii. Sand and water should be mixed in the container, then the water should be poured out
    - iii. Repeat until water runs clear
  - b. The drums should be filled with (see figure 11):
    - i. First, lay a 5 cm layer of coarse gravel
    - ii. Second, lay a 5 cm of fine sand
    - iii. Finally, lay a 50 cm layer of coarse sand
4. Diffuser plate
- a. The diffuser plate evenly distributes the water coming into the filter to ensure that water does not splash and disrupt the sand
  - b. Place the diffuser plate 10 cm above the top layer of sand
  - c. It must be a circular plate that is 70 cm in diameter
  - d. It can be made from a perforated plastic bin or rustproof metal sheet
  - e. Must be removable
5. Maintenance
- a. The filter needs to be cleaned regularly
  - b. When adding wastewater into the filter, it should be slowly poured over the diffuser plate

## Glossary

**Anaerobic:** pertaining to or caused by the absence of oxygen.

**Black water:** Wastewater containing bodily or other biological wastes, as from toilets, dishwashers, or kitchen drains.

**Clogging:** to hinder or obstruct with thick or sticky matter; choke up

**Compost:** a mixture of various decaying organic substances, as dead leaves or manure, used for fertilizing soil.

**Composting:** To convert organic matter into compost

**Disposal:** the act or means of getting rid of something

**Efficiency:** An accomplishment of or ability to accomplish a job with a minimum expenditure of time and effort. In terms of sanitation, efficiency refers to level of odors and flies.

**Effluent:** This is a liquid resulting from the storage or treatment of wastewater and excreta that has already undergone partial or complete treatment. Depending on the level of treatment already applied, it can be used or discharged, or have to undergo further treatment.

**Excreta:** waste matter, such as urine, faeces, or sweat, discharged from the body

**Grey water:** wastewater produced from human activity such as baths and showers, clothes washers, and lavatories.

**Groundwater Table:** the upper limit of the saturated soil body, also referred to as water table

**Groundwater:** Water that collects or flows beneath the Earth's surface, filling the porous spaces in soil, sediment, and rocks. Groundwater originates from rain and from melting snow and ice and is the source of water for aquifers, springs, and wells.

**Improved Sanitation:** an improved sanitation facility is defined as one that hygienically separates human excreta from human contact

**Infrastructure:** the fundamental facilities and systems serving a country, city, or area, as transportation and communication systems, power plants, and schools.

**Latrine:** a receptacle (as a pit in the earth) for use as a toilet

**Municipal Collection:** the governmental gathering of solid waste and recyclable materials and transporting them to the location where the collection vehicle is emptied

**Organic Waste:** The organic waste stream is composed of waste of a biological origin such as paper and cardboard, food, green and garden waste, animal waste and biosolids and sludges.

**Pathogen:** An agent that causes disease, especially a living microorganism such as a bacterium or fungus



**Percolation:** To cause (liquid, for example) to pass through a porous substance or small holes; filter

**pH:** the acidity or alkalinity of a solution on a scale of 0 to 14, where less than 7 represents acidity, 7 neutrality, and more than 7 alkalinity.

**Recyclable:** capable of being used again

**Recycle:** to treat or process (used or waste materials) so as to make suitable for reuse

**Runoff:** something that drains or flows off, as rain that flows off from the land in streams

**Sanitation:** the promotion of hygiene and prevention of disease by maintenance of sanitary conditions (as by removal of sewage and trash)

**Scum:** A filmy layer of extraneous or impure matter that forms on or rises to the surface of a liquid or body of water.

**Sewage:** The contents of a sewer or drain; refuse liquids or matter carried off by sewers

**Sludge:** Semisolid material such as the type precipitated by sewage treatment

**Solid Waste:** Solid or semisolid, insoluble material (including gases and liquids in containers) such as agricultural refuse, demolition waste, industrial waste, mining residues, municipal garbage, and sewage sludge.

**Squatter Community:** a group of individuals who settle on land or occupy property without title, right, or payment of rent

**Surface Water:** Water naturally open to the atmosphere; water from estuaries, lakes, ponds, reservoirs, rivers, seas, etc.

**Ventilation:** a system or means of providing fresh air

**Wastewater:** Water that has been used, as for washing, flushing, or in a manufacturing process, and so contains waste products

## References

- Calvert, P. (2005). Compost toilets. Warwickshire, UK: The Schumacher Centre for Technology & Development. [Online]
- Chatterton, K. (2002). Emergency sanitation: Assessment and programme. Design, Water, Engineering and Development Centre Loughborough University. Retrieved from <http://helid.digicollection.org/en/d/Js2669e/1.html>
- Davis, M. L., & Masten, S. J. (2009). Wastewater treatment. In Principles of Environmental Engineering and Science (Second Edition ed., pp. 457-481). New York, NY: McGraw-Hill.
- DuPoldt, C., Edwards, R., Garber, L., Isaacs, B., Lapp, J., Murphy, T., Webster, H. (1994). A handbook of constructed wetlands. Washington, D.C.: United States Government Printing Office. [Online]
- Frenoux, C., Gabert, J., Guillaume, M., & Monvois, J. (2011). How to select appropriate technical solutions for sanitation. Cotonou and Paris: Partenariat pour le Développement Municipal (PDM) and Programme Solidarité Eau (pS-Eau). [Online]
- Huuhtanen, S., & Laukkanen, A. (2006). A guide to sanitation and hygiene for those working in developing countries. Tampere, Finland: Tampere Polytechnic University of Applied Sciences Publications. [Online]
- Lüthi, C., Morel, A., Schertenleib, R., Tilley, E., & Zurbrügg, C. (2008). Compendium of sanitation systems and technologies. (Report No. 978-3-906484-44-0). Switzerland: Eawag-Sandec. [Online]
- Minnesota Small Urban Sites. (2001). Infiltration trenches. Barr Engineering Company. [Online]
- Rural Africa Water Development Project. (2011). Mor-sand filter. Retrieved December 1, 2011, from: [http://www.rawdp.org/Home\\_Page.html](http://www.rawdp.org/Home_Page.html)
- Shaw, R. (2002). Emergency sanitation: Assessment and programme design. Water, Engineering and Development Centre Loughborough University. Retrieved from <http://helid.digicollection.org/en/d/Js2669e/1.html>
- Torfaen County Borough Council. (2010). Composting [Diagram], Retrieved November 28, 2011, from

<http://www.torfaen.gov.uk/EnvironmentAndPlanning/RubbishWasteAndRecycling/Composting/Images/How%20Compost%20Happens.gif>

- US EPA. (1998). Constructed wetlands design manual (Report No. EPA/625/1-88/022). Washington, D.C.: Office of Research and Development. [Online]
- US EPA. (1999a). Storm water technology fact sheet infiltration trench. (Report No. EPA 832-F-99-019). Washington, D.C.: Office of Water. [Online]
- US EPA. (1999b). Wastewater technology fact sheet intermittent sand filters. (Report No. EPA 932-F-99-067). Washington, D.C.: Office of Water. [Online]
- US EPA. (1999c). Water efficiency technology fact sheet composting toilets. (Report No. EPA 832-F-99-066). Washington, D.C.: Office of Water. [Online]
- US EPA. (2002). A homeowner's guide to septic systems. (Report No. EPA-832-B-02-005). Washington, D.C.: Office of Water. [Online]
- US EPA. (2004). Constructed treatment wetlands. (Report No. EPA 843-F-03-013). Washington, D.C.: Office of Water. [Online]
- US EPA. (2011a). Resource conservation: Composting. Retrieved from <http://www.epa.gov/osw/conserves/rrr/composting/basic.htm>
- US EPA. (2011b). Resource conservation: Recycling. Retrieved from <http://www.epa.gov/osw/conserves/rrr/recycle.htm>
- WHO. (1996). Fact sheets on environmental sanitation. Geneva, Switzerland: WHO Press. [Online]
- Wolfgang, B., Deutsche gesellschaft für technische zusammenarbeit (2010). Basic Overview of Composting Toilets. Retrieved December 4, 2011 from: <http://www.gtz.de/en/dokumente/gtz2010-en-technology-review-composting-toilets.pdf>
- Wright, M., (1996). Safe use of household greywater. Las Cruces, New Mexico: New Mexico State University. [Online]

Vérsion

1

UN TECHO PARA MI PAIS- COSTA RICA

---

En cooperación con Worcester Polytechnic Institute



Aaron Behanzin, Caroline Concannon, Olivia Doane, & Mackenzie Ouellette

14 Diciembre, 2011

# Manual del Manejo de Residuos

## Tabla de Contenidos

Prólogo .....	iii
Tabla de Iconos .....	v
Criterios de Selección .....	vii
Costos de las Materiales.....	viii
Manejo de Residuos Sólidos.....	1
Prólogo .....	1
Tabla de Manejo de Residuos Sólidos .....	2
Reciclar .....	3
Papelerera de reciclaje .....	3
El Compostaje.....	5
Materiales que pueden ser compostados.....	5
Pozo de Desechos .....	8
Colección Municipal.....	9
Manejo de Residuos Humanos.....	10
Prólogo .....	10
Cuadro de Manejo de Residuos Humanos .....	11
Letrina de pozo sencilla: .....	12
Letrina de pozo ventilado.....	18
Letrina con cierre hidráulico.....	21
Letrina de Compostaje: .....	25
Letrina de Compostaje con Desviación de Orina .....	32
Sistema de tanque séptico: .....	35

Humedales Construidos .....	41
El Pozo Seco .....	48
Fosa de percolación.....	53
Filtro de Arena .....	56
Glosario.....	59
Referencias.....	62

## **Prólogo**











En los capítulos siguientes se describen opciones posibles del manejo de los residuos sólidos y humanos que se aplicará en las comunidades empobrecidas. Que permite a los miembros de la comunidad a tomar una decisión respecto a qué plan de mejora del manejo de residuos es apropiado para ellos. Cada capítulo de este manual es precedido por una tabla que permite al usuario determinar visualmente qué solución puede ser apropiada para las condiciones. Se incluyeron instrucciones específicas sobre cómo se construye cada solución, cuánto cuesta el plan, y cómo mantener el sistema. Mediante la implementación de un sistema mejora del manejo de residuos en las comunidades empobrecidas, la calidad de vida de los residentes puede ser enriquecido.













## Tabla de Iconos

Esta tabla muestra los iconos que se utilizan en las tablas de decisión incluidos en este manual y el rango que cada icono representa.

Limitación	Icono
Espacio Disponible	 10 m <sup>2</sup> +
	 5-9 m <sup>2</sup>
	 0-4 m <sup>2</sup>
Costo	 302.001 CRC +
	 151.001-302.000 CRC
	 0-151.000 CRC
Residuos Inorgánicos	
Residuos Orgánicos	
Reciclaje	
Mantenimiento	 Requiere un profesional

	 <p>Requiere habilidad moderada</p>
	 <p>Requiere habilidad poca o ninguna</p>
<b>Escorrentía de patógenos</b>	 <p>Mayor</p>
	 <p>Menor</p>
<b>Longevidad</b>	 <p>16+ años</p>
	 <p>6-15 años</p>
	 <p>0-5 años</p>
<b>Eficiencia</b>	 <p>Moscas y olores</p>
	 <p>No moscas o olores</p>

## **Criterios de Selección**

Para seleccionar el sistema de gestión de los residuos humanos más adecuado para una comunidad dada, hay que tener en cuenta los siguientes criterios:

- Información básica sobre las características demográficas y las prácticas culturales relacionadas con el saneamiento de la comunidad
- La disponibilidad de agua para ser utilizados en el saneamiento
- Las prácticas actuales de saneamiento
- Profundidad del nivel freático y la cercanía de la comunidad a la fuente de agua
- Clima de la comunidad, incluyendo la precipitación anual y la frecuencia de las inundaciones
- Disponibilidad de espacio físico para un sistema de saneamiento a implementar
- La disponibilidad de recursos, tales como finanzas, servicios profesionales, contratistas y trabajadores manuales
- El tipo de residuos producidos por la comunidad, tales como los residuos orgánicos y materiales reciclables

## Costos de las Materiales

Los precios incluidos en este manual se calculan a partir de los precios de los materiales vendidos por unidad que figuran en la EPA en Curridabat, San José, Costa Rica. Que debe ser entendido como un precio aproximado. Los precios se muestran en la siguiente tabla.

Las Materiales	Costo CRC
El hormigón	¢5.000 por 50 kg
8 in x 8 in x 16 in ladrillo de hormigón	¢630 cada
Mortero de cemento	¢4.500 por L
La madera tratada	¢5.500 por 5544 cm <sup>3</sup>
Contenedores reciclados de plástico	¢17.000 cada
250 L Tambor de plástico	¢43.000 cada
½" de diámetro tubería de PVC	¢500 por 3 m
1" de diámetro tubería de PVC	¢2.000 por 3 m
4" de diámetro tubería de PVC	¢4.000 por 3 m
1" de diámetro en forma de T tubería de PVC	¢300 cada
4" de diámetro en forma de T tubería de PVC	¢3.500 cada
1" de diámetro en forma de codo tubería de PVC	¢500 cada
0.25 m de diámetro cubo de plástico	¢3.000 cada
Chapa ondulada	¢5.500 para 81 cm x 505 cm
La bandeja de agua lluvia-rubor de cerámica	¢4.000
30 mil revestimiento de PVC	¢5.000 por m <sup>2</sup>
Las plantas acuáticas (completamente desarrollado)	¢4.500 cada
La grava	¢3.000 por 0.0189 m <sup>3</sup>
La arena fina	¢13.500 por 1000 kg
La arena gruesa	¢25.000 por 1000 kg
19 cables de acero por cada pulgada paño de malla	¢90 para 1 cm <sup>2</sup>
70 cm de diámetro recipiente de plástico	¢2.500 cada
Recipiente de plástico con tapa para el compostaje y el reciclaje	¢17.000 cada



















# Manejo de Residuos Sólidos

*El capítulo siguiente resume opciones de manejo de residuos sólidos para comunidades de los países de América Latina.*

## **Prólogo**

Esta sección del manual incluye datos sobre prácticas del manejo de residuos sólidos que podrían ser utilizados en las comunidades empobrecidas. Información sobre la implementación, uso y mantenimiento de las 4 opciones del manejo de residuos sólidos está incluido. Sólo se incluyeron las soluciones más viables para los residentes de las comunidades empobrecidas. La mayoría de estas opciones pueden ser implementadas y mantenidas por los propios residentes. Sin embargo, algunas prácticas requieren de un mantenimiento de la municipalidad. El cuadro que figura en esta guía es para ser utilizado como una herramienta para determinar la solución más factible. La mayoría de la información incluida en este capítulo del manual se basa en las directrices de Estados Unidos Agencia de Protección Ambiental para Reducir, Reutilizar y Reciclar en 2011. Se obtuvo información adicional a través de las fuentes mencionadas en la sección de referencias de este documento.

**Tabla de Manejo de Residuos Sólidos**





	Tipo de Residuos			Costo de Implementación	Costos Recurrentes	Espacio Requerido
Reciclaje					nada	
Compostaje					nada	
Colección Municipal						
Pozo de Desechos					Nada	

## Reciclar



**Papelera de reciclaje**

- ¿Qué materiales se pueden reciclar?
  - Vidrio, plástico, cartón, aluminio, papel

 Vidrio	 Plástico	 Cartón	 Papel
 Aluminio			

- ¿Cómo puedo reciclar?
  - Este método se lleva a cabo mediante la separación de los materiales reciclables y llevándolos al centro de recolección local a cambio de dinero
- ¿Por qué debo reciclar?
  - rentable
  - Ahorra recursos naturales-requiere menos energía para hacer algo a partir de materiales reciclados
  - Ahorra espacio en los vertederos
- ¿Qué necesito considerar sobre el reciclaje?

- Toma tiempo para hacer
- Según el gobierno local, una persona en la comunidad tiene que tener un carro para ser capaz de tomar los materiales reciclables al centro de reciclaje local



## El Compostaje



### Materiales que pueden ser compostados

- ¿Qué materiales puedo usar en el compostaje?
  - Materiales marrones: proporciona carbono
    - Papel, cartón, las hojas, los gemelos, el suelo
  - Materiales verdes: provee nitrógeno
    - Recortes de la hierba, las cáscaras de verduras, cáscaras de frutas, los granos de café
- ¿Qué materiales no puedo usar en el compostaje?
  - Metales, productos lácteos, carne, plástico, plaguicidas químicos
- ¿Cuántas personas pueden utilizar un cubo de compostaje?
  - El compostaje se puede realizar individualmente o en toda la comunidad- sólo varía el tamaño de la cuchara usada!
  - Puede ser tan pequeño como una caja de plástico o tan grande como un contenedor de basura
- ¿Qué puedo hacer el compostaje en?
  - Si el compostaje de las hojas y materiales del aire libre
    - Un montón de descritos por cable o desechos de madera
  - Si el compostaje de alimentos
    - Superior-cerrado compartimiento



### **Cubo de compostaje sencilla con tapa**

- ¿Dónde debo hacer el compostaje?
  - La mejor ubicación para un cubo de abono está en el sol directamente sobre el suelo y lejos de cualquier fuente de agua
- ¿Cuánto tiempo toma para completar el compostaje?
  - Rápido: Toma de 6-8 semanas
    - necesitan suficiente material para llenar un contenedor completo
    - Llenar de agua conforme lo va llenado de compostaje
    - El compostaje se calienta, revolver cuando se enfría
    - Si está seco, agregar el agua y si se satura añadir material seco
    - Cuando ya no se calienta de nuevo, deje tranquilo a fin de compostaje
  - Disminuya la velocidad: Toma de hasta un año de abono completo
    - la necesidad suficiente para llenar una capa de al menos 30 cm
    - Para mejorar la circulación de aire y drenaje, colocar ramitas en el fondo
    - Cuando el abono de las capas inferiores composta, se puede utilizar en un jardín y mezclar el resto de compost
    - Si está seco agregar el agua y si se satura añadir material seco

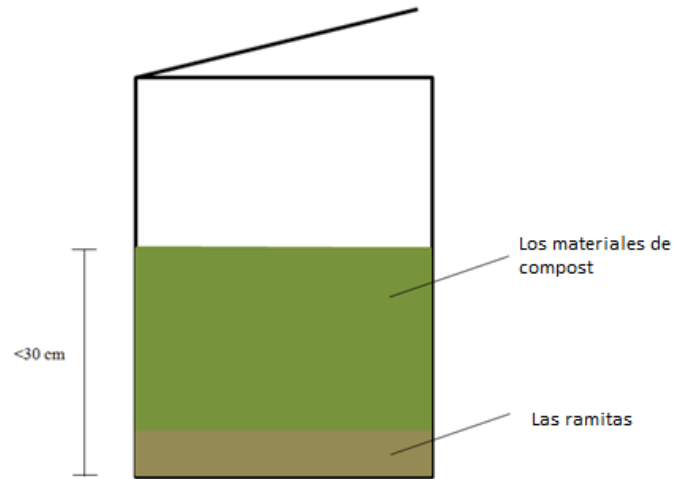

**Capas de compostaje lento**

- ¿Por qué debería compost?
  - Rentable
  - Reduce la producción de metano en rellenos sanitarios en el medio ambiente
  - puede ayudar a enriquecer su tierra mediante la introducción de microorganismos, lo que reduce la necesidad de fertilizantes
- ¿Qué necesito considerar sobre el compostaje?
  - Requiere de trabajo y mantenimiento
  - Necesidad de espacio

## Pozo de Desechos

- ¿Qué materiales se pueden utilizar?
  - Todos los materiales no reciclables
- ¿Dónde debe estar ubicado mi pozo?
  - Sobre el nivel del agua subterránea para eliminar la contaminación de residuos químicos y peligrosos
  - Por lo menos 20 metros de la zona de la cocina
  - Distancia segura de la fuente de agua dependiendo de su ubicación
  - No por encima de cualquier tubería que desemboca en las aguas superficiales
  - El pozo debe tener una base sellada para evitar que se contaminen las aguas subterráneas
  - Deben ser cubiertos
  - Los niños y los animales no deben tener acceso a un pozo de desechos debido a los materiales peligrosos
- ¿Cómo puedo hacer mi pozo dura por mucho tiempo?
  - Mediante la compactación de la pila, puede encajar más basura en el pozo y por eso dura por más tiempo
- ¿Por qué debo utilizar un pozo de desechos?
  - Es una buena manera para compactar los residuos que no pueden ser eliminados de cualquier otra manera
  - Es de uso gratuito
- ¿Qué debo tener en cuenta con un pozo de desechos?
  - Ocupa mucho espacio
  - Tienen que ser muy cuidado acerca de los riesgos de salud y la ubicación del pozo

## **Colección Municipal**

- ¿Qué se puede recoger?
  - Todos los tipos de residuos
- ¿Cómo puedo obtener este servicio?
  - Pagar municipal local para la recolección de basura
    - Costo y regularidad varían dependiendo de la región
- ¿Por qué debo obtener mi basura recogida?
  - Todos los residuos se recogen y se tratan en otros lugares
- ¿Qué debo considerar sobre la recolección municipal?
  - Caro (costo continuo)
  - Material reciclable y compostable se mezclan con toda la basura que se trata; puede ser malo para el medio ambiente



















































## Manejo de Residuos Humanos

*El capítulo siguiente resume opciones de manejo de residuos humanos para comunidades de los países de América Latina.*

### Prólogo

Esta guía incluye los datos relativos a los servicios de saneamiento que se podrían utilizar en las comunidades empobrecidas. Esta guía incluye información acerca de la implementación, uso y mantenimiento de 10 sistemas de saneamiento. Hemos determinado únicamente las soluciones más viables para los residentes de las comunidades empobrecidas deben ser incluidos. La mayoría de estas opciones pueden ser implementadas por los propios residentes. Sin embargo, algunas prácticas de higiene requieren profesional de la construcción y/o de planificación. Las prácticas de saneamiento que entran en esta categoría han sido claramente indicadas. El cuadro que figura en esta guía es para ser utilizado como una herramienta para determinar la solución más factible. La mayoría de la información incluida en este manual se basa en hojas de la Organización Mundial de la Salud de Datos Saneamiento. Se obtuvo información adicional a través de las fuentes mencionadas en la sección de referencias de este documento.

## Cuadro de Manejo de Residuos Humanos

	Costo de implementación	Costo de Mantenimiento	Eficiencia	Facilidad de mantenimiento	Espacio requerido	La escorrentia de patógenos	longevidad
Letrina de pozo sencilla					m <sup>2</sup>	+	
Letrina de pozo ventilada					m <sup>2</sup>	+	
Letrina con cierre hidráulico					m <sup>2</sup>	+	
Letrina de compostaje					m <sup>2</sup>	-	
Letrina de compostaje con desviación de orina					m <sup>2</sup>	-	
Sistema séptico					m <sup>2</sup>	-	
Humedales construidos					m <sup>2</sup>	-	
Pozo seco					m <sup>2</sup>	-	
Fosa de percolación					m <sup>2</sup>	-	
Filtro de arena					m <sup>2</sup>	-	

## Letrina de pozo sencilla:

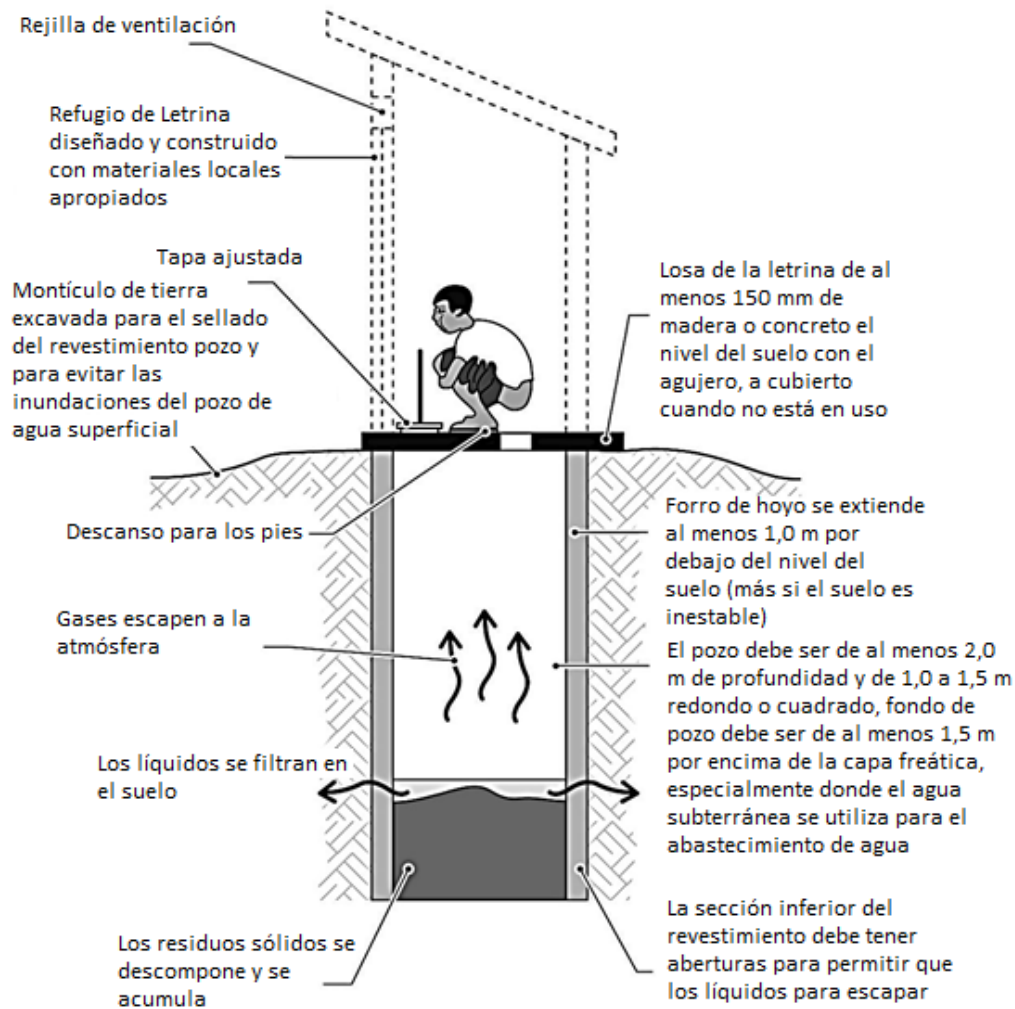

### Letrina de pozo sencilla (Imagen cortesía de WEDC Chatterton © Ken, 2002)

Una letrina de pozo sencilla consiste en un pozo cavado en la tierra, cubierto por una losa de higiene o en el suelo con un agujero donde los desechos humanos pueden pasar al pozo. Hay muchas variaciones en esta letrina de pozo sencilla, como la inclusión de una tapa que ajuste bien para tapar el agujero para reducir los olores y la cría de moscas. Cuando la fosa se llena a 50 centímetros por debajo del agujero, puede ser cubierto y una nueva letrina de pozo sencilla debe ser creado. El pozo también puede ser cubierto con una variedad de materiales, incluyendo los bloques de hormigón, ladrillos y tambores perforados de petróleo. También se puede vaciar por un profesional. La letrina se debe limpiar con un desinfectante por los usuarios. Simples letrinas a cielo tienen a menudo un refugio construido a partir de materiales disponibles, como la madera



y chapa ondulada. Este refugio sólo necesita lo suficientemente grande como para albergar el agujero en el suelo y un usuario.

<b>Información Básica</b>	
Coste medio de ejecución	¢26.000-66.000 CRC
El coste medio anual de mantenimiento	¢3.300-9.800 CRC
Facilidad de implementación	Fácil
Facilidad de mantenimiento	Fácil
Eficiencia	Las moscas y los olores presentes
Tamaño	Requiere 0.06 m <sup>3</sup> de volumen por persona y año de uso previsto + 0.5 m de profundidad para cubrir con tierra cuando están llenos
Duración de vida	5-10 años

<b>Ventajas</b>	<b>Desventajas</b>
Bajos costes de mantenimiento y puesta en práctica	Las moscas y los olores prevalentes
Fácil de construir	Escorrentía de los principales patógenos
Materiales fácilmente disponibles	

<b>Limitaciones</b>
Debe ser implementado en un área donde la capa freática es de al menos 2 m desde el fondo de la fosa y no debe penetrar en las aguas subterráneas
Debe ser construido por lo menos 30 m del pozo
Debe ser construido por lo menos 30 metros de río
Debe ser construido alrededor de 6 m de la casa
Se debe construir hacia abajo de la fuente de agua

### **Construcción:**

1. Calcular el volumen de la fosa debe contener y cavar agujeros
  - a. Por ejemplo, una familia de 5 que tiene que usar la letrina de pozo durante 10 años las necesidades de una letrina de pozo que es de 1.8 m<sup>3</sup>
    - i.  $0.06 \frac{m^3}{personas \times year} \times 5 \text{ personas} \times 10 \text{ años} = 3 m^3$
  - b. El agujero debe tener esta capacidad de volumen, más de 0.5 m de profundidad, para que cuando se llena, puede ser cubierto con tierra
  - c. Esto se puede lograr mediante la creación de un agujero rectangular de 1 m de ancho y 1 m de largo y 3.5 m de profundidad
  - d. Agujero puede ser cilíndrica o rectangular

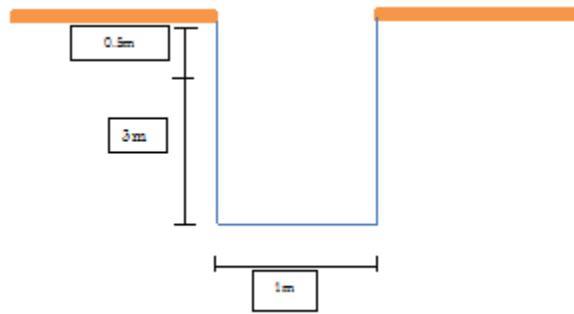

**Letrina de pozo sencilla, paso 1**

2. Línea el pozo

- a. Pozos pueden ser cubiertas con bloques de hormigón, ladrillos, mampostería, escombros, piedras, tambores perforados de petróleo, o de madera imputrescible para proporcionar apoyo a la placa en la que el usuario se encuentra
- b. La cantidad de materiales necesarios para la línea de la boca depende del tamaño de la fosa
  - i. Por ejemplo, para un hueco rectangular que mide 1 m de ancho y 1 m de largo y 3.5 m de profundidad, el revestimiento del pozo serían necesarios  $14 \text{ m}^2$  de materiales para cubrir los lados de la fosa
  - ii.  $4 \times (1 \text{ m} \times 3.5 \text{ m}) = 14 \text{ m}^2$
- c. Revestimiento de mortero sólo deben ser de 0.5 m de la superficie para permitir que los residuos líquidos a penetrar en el suelo

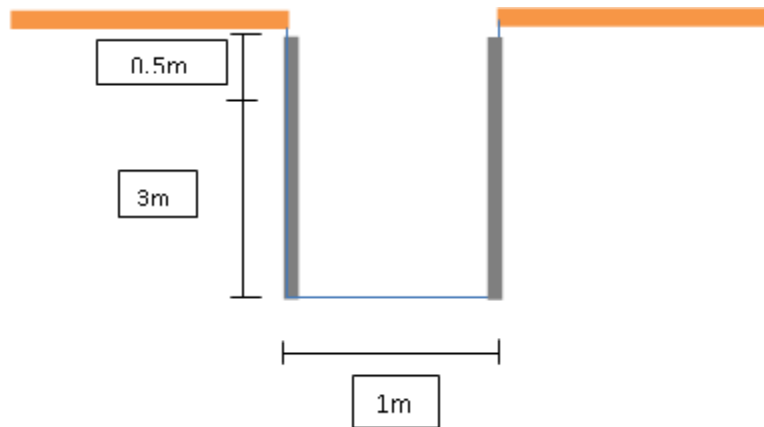

**Letrina de pozo sencilla, paso 2**

### 3. Fundación

- a. a. La fundación puede ser de concreto, ladrillo, o una termita madera resistente
- b. Una fundación debe ser construida para apoyar la placa en cuclillas, para evitar las inundaciones por las lluvias, y para evitar que los roedores de la excavación en el pozo
- c. Se debe más de 0.1 m por encima del nivel del suelo fuera de la fosa
- d. Por ejemplo, para un hueco rectangular que mide 1 m de ancho y 1 m de largo y 3.5 m de profundidad y tiene una fundación que es de 0.1 m por encima del suelo necesita un adicional de  $0.4 \text{ m}^2$  de materiales para la fundación

i.  $4 \times (1 \text{ m} \times 0.1 \text{ m}) = 0.4 \text{ m}^2$

### 4. Construcción de montículos (si es necesario)

- a. Un montículo es necesario si el nivel freático está a menos de 2 m por debajo del fondo del pozo o la roca es sólida, que plantea la letrina
- b. Las paredes del pozo y el revestimiento debe ser construido por lo menos 1.2 m de la superficie de la tierra
- c. Concreto se agrega a la estructura de apoyo, las medidas también sí pueden agregar utilizando cemento

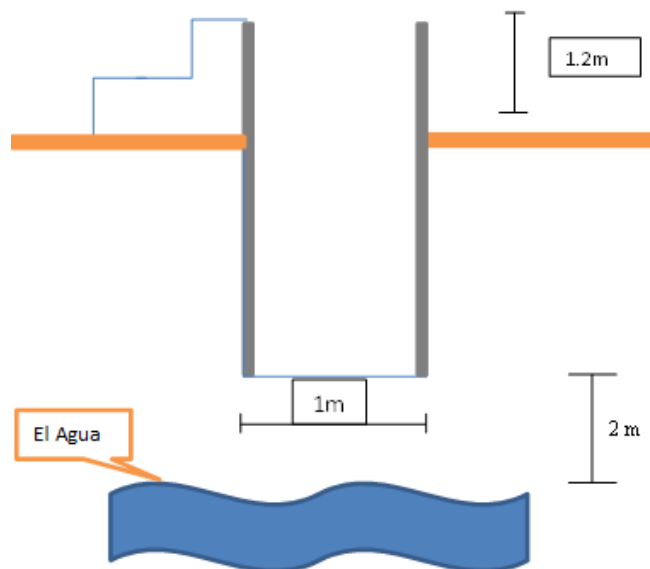

**Letrina de pozo sencilla, paso 4**

## 5. La Losa en cuclillas

- a. La losa en cuclillas ayuda al usuario y cubre la fosa. Por esta razón, la losa debe ser más grande que el propio pozo
- b. La tabla puede ser hecha de madera o de hormigón. Concreto previene la infección por anquilostomas
- c. La losa debe tener un agujero que los excrementos pueden pasar a través en el pozo
- d. La pendiente de la losa se inclinan hacia el agujero para permitir que los desechos de drenaje en el orificio
- e. La apertura debe ser inferior a 0.25 m en cualquier dirección para evitar que un niño de caer en la letrina de pozo
- f. La tabla puede tener un asiento construido en la parte superior del hueco para la comodidad o el usuario puede ponerse en cuclillas sobre el agujero

## 6. Tapa

- a. Una tapa de cierre hermético es necesario evitar que las moscas y los olores
- b. Esta tapa es generalmente hecha de madera y tapa el agujero
- c. Por un orificio circular que es de 0.25 m de diámetro, una tapa que es de 0.05 m<sup>2</sup> en la zona es necesario

- i.  $\pi\left(\frac{0.25\text{ m}}{2}\right)^2 = 0.05\text{ m}^2$

## 7. Albergue

- a. El refugio ofrece privacidad para el usuario y la protección del clima
- b. El refugio se puede hacer de cualquier material disponible
  - i. Ejemplo: los ladrillos, el estaño

## 8. Mantenimiento

- a. La puerta de la caseta debe mantenerse cerrada
- b. El agujero de defecación de la letrina se mantendrá cerrada con la tapa para evitar que las moscas entrar en la letrina
- c. La planta de letrinas deben limpiarse diariamente
- d. Los residuos orgánicos pueden ser depositados en la letrina (nota: se reducirá la vida útil de la letrina)
  - i. Para disminuir los olores de la letrina, verduras, cáscaras de frutas, aserrín y hojas se pueden añadir en la letrina

- e. El pozo debe ser lo más seca posible para evitar que los mosquitos se reproducen en la fosa
  - i. Para reducir el contenido de agua en el pozo o las cenizas de estiércol de vaca seca se puede agregar en la ayuda a absorber el agua y puede reducir los olores

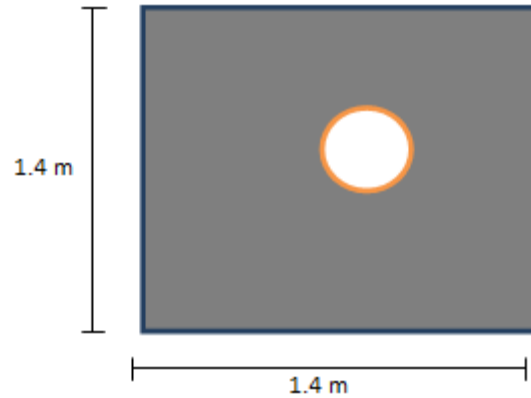

**Letrina de pozo sencilla, paso 8**

- f. Ningún desinfectante debe ser añadido a la fosa
- g. En caso de brote de la epidemia en el piso debe ser limpiado a diario todos los días con un desinfectante como cloro

## Letrina de pozo ventilado

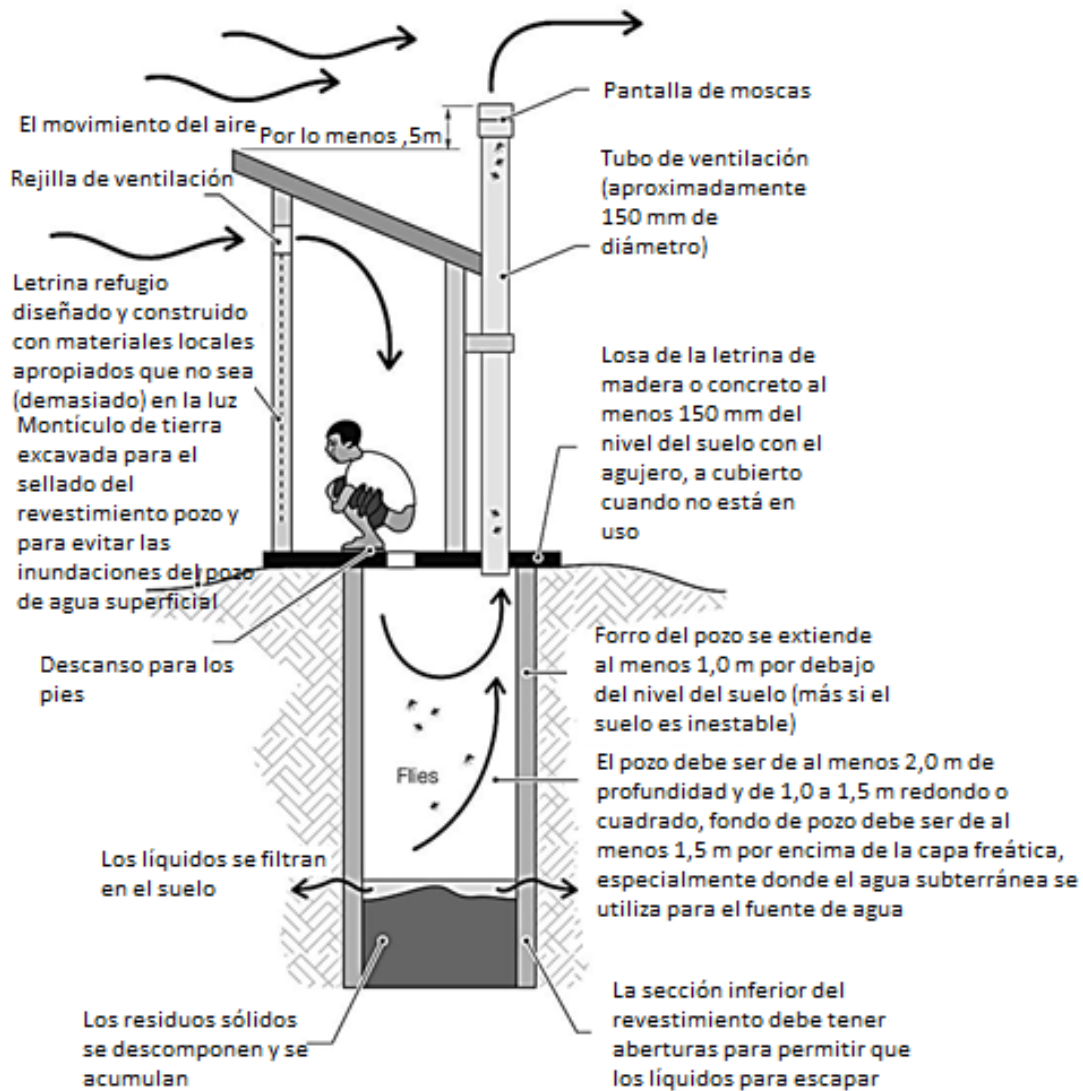

Letrina de pozo de ventilación mejorada (Imagen cortesía de WEDC Chatterton © Ken, 2002)

Letrinas de pozo pueden estar mejoradas para mejorar la higiene y minimizar los riesgos potenciales para la salud por la adición de un tubo de ventilación. El resultado de la modificación es una letrina de pozo ventilado mejorado, que reduce o elimina los problemas de olor y las moscas se reproducen en el pozo.

<b>Información Básica</b>	
Coste medio de la implementación	¢6.600-131.000 CRC
El coste medio anual de mantenimiento	¢3.300-9.800 CRC
Facilidad de la implementación	Fácil
Facilidad del mantenimiento	Fácil
Eficiencia	Las moscas y los olores presentes
Tamaño	Requiere 0,06 m <sup>3</sup> de volumen por persona por año de uso previsto + 0,5 m de profundidad para cubrir con tierra cuando está lleno
Duración de vida	5-10 años

<b>Ventajas</b>	<b>Desventajas</b>
Bajos costes de mantenimiento y implementación	Las moscas y los olores prevalentes
Fácil para construir	Mucho escurrimiento de patógenos
Materiales fácilmente disponibles	

<b>Limitaciones</b>
Tiene que estar implementado en un área donde la capa freática es de al menos 2 m del fondo del pozo y no debe penetrar en las aguas subterráneas
Tiene que estar construido por lo menos 30 m del pozo
Tiene que estar construido por lo menos 30 m del río
Tiene que estar construido aproximadamente 6 m de la casa
Debe estar construido cuesta abajo de la fuente de agua
Tiene que estar construido lejos de ramas de los árboles

## **Construcción**

Lo mismo como la letrina de pozo sencilla, pero con los cambios siguientes

1. La Losa de cuclillas
  - a. La losa tiene que tener un agujero de la tubería de ventilación (diámetro de 0,1 m) para permitir la instalación de la rejilla de ventilación

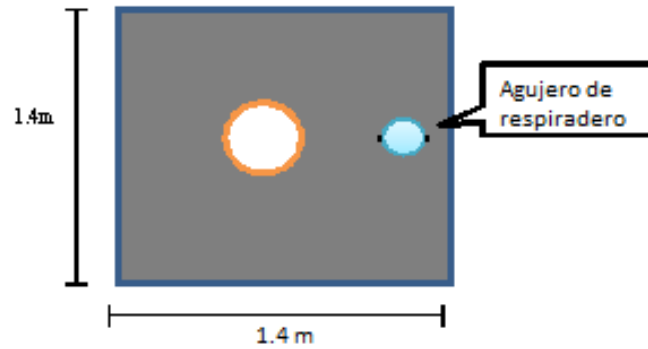

**Letrina de pozo de ventilación mejorada, Paso 1**

2. El tubo de ventilación
  - a. Debe tener un diámetro interior de 0,1 m
  - b. Debe tener una pantalla de moscas en la abertura superior
    - i. Pantallas de metal tienden a deteriorarse a causa de los gases que surgen de la tubería
    - ii. Recubierto de PVC malla de fibra de vidrio puede estar utilizado, pero no durará más que 5 años
  - c. Debe ser de color oscuro y tiene paredes finas
    - i. Los ejemplos adecuados: PVC pintado negro o fibra de cemento
  - d. Puede consistir en una chimenea de ladrillo (diámetro interno no debe ser menos de 0.225m)



## Letrina con cierre hidráulico

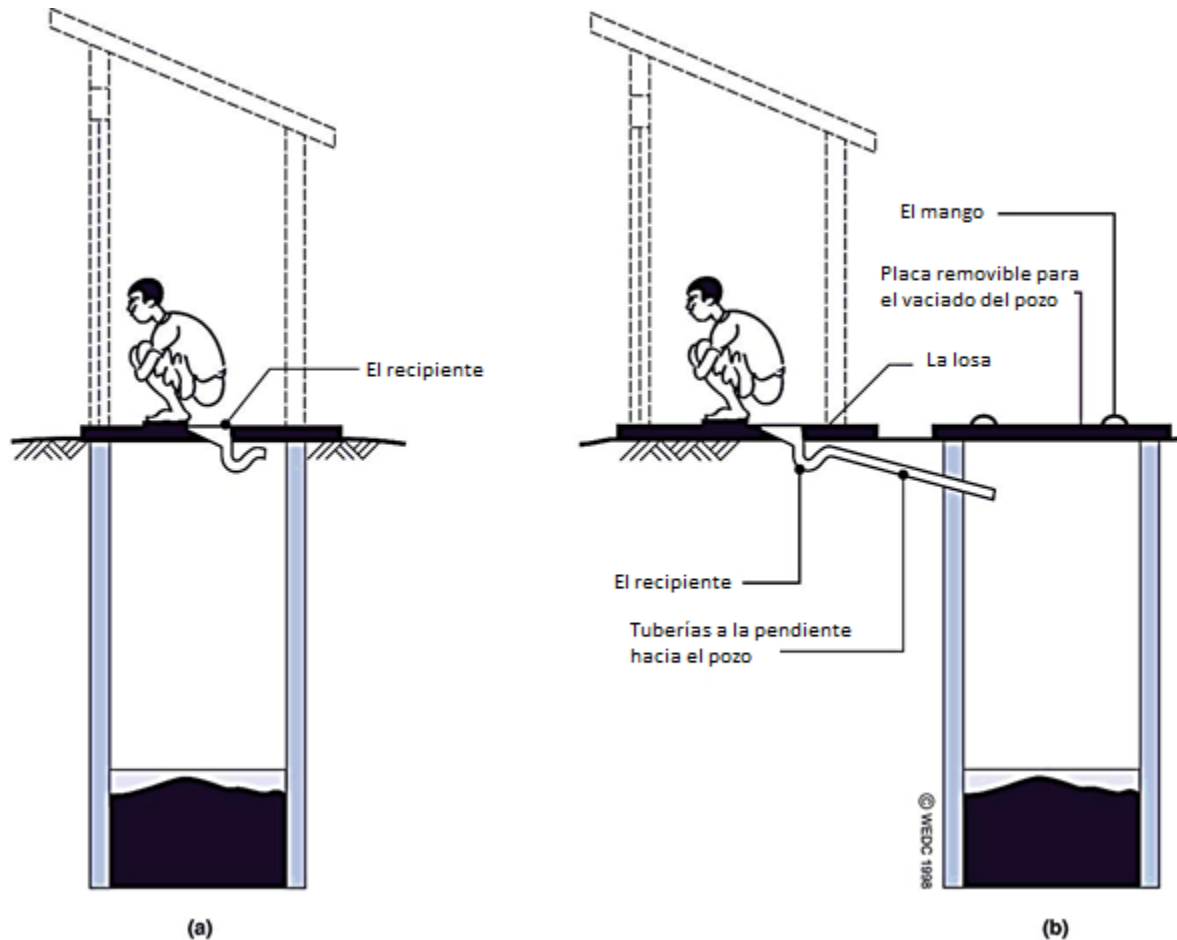

Una básica letrina con cierre hidráulico (a) y una variante (b) (Imagen cortesía de WEDC © Varilla Shaw, 2006).

La letrina con cierre hidráulico difiere de una letrina de pozo sencilla, debido a que cuenta con un recipiente en lugar de un agujero en la losa. El agua en el recipiente bloquea olores de entrar en el refugio del pozo. Funciona mediante la adición de 2-3 L de agua después de cada uso para eliminar los excrementos del recipiente en el pozo. Una letrina con cierre hidráulico es adecuada para zonas donde el agua es abundante y es fácilmente disponible. Muchas modificaciones al diseño básico pueden ser construido para aumentar la vida útil y la eficiencia de la letrina (ver sección de la construcción). Como una letrina de pozo sencilla, una letrina con cierre hidráulico se llenará y se deberá excavar un nuevo pozo. Sin embargo, las letrinas de cierre hidráulico pueden construir estructuras permanentes, si el lodo se retira cuando el pozo

está a plena capacidad. La posibilidad de la eliminación de los lodos depende del diseño de la latrina con cierre hidráulico.

<b>Información Básica</b>	
Costo medio de implementación	☉33.000-9.800 CRC
El costo medio anual de mantenimiento	☉3.300-66.000 CRC
Facilidad de implementación	Fácil
Facilidad de mantenimiento	Fácil
Eficiencia	No hay olores ni moscas, la basura no es tratada
Tamaño	Requiere 0,06 m <sup>3</sup> de volumen por persona por año de uso previsto + 0,5 m de profundidad para cubrir con tierra cuando están llenos
Duración de vida	5-10 años

<b>Ventajas</b>	<b>Desventajas</b>
Bajo mantenimiento	Más caro que una letrina de pozo
Fácil de construir	Limpieza de materiales puede causar un bloqueo en la sartén
Materiales fácilmente disponibles	Requiere una fuente constante de agua
No hay problema de olor o la presencia de las moscas	Puede requerir la educación con el fin de utilizar correctamente

<b>Limitaciones</b>
Tiene que estar implementado en un área donde la capa freática es al menos 2m del fondo del pozo durante la temporada de lluvias y no debe penetrar en las aguas subterráneas
Tiene que estar construido por lo menos 30m del pozo
Tiene que estar construido por lo menos 30 m del río
Tiene que estar construido alrededor de 6 m de la casa
Debe estar construido cuesta abajo de la fuente de agua

## **Construcción**

Igual que la letrina de pozo sencilla, pero con los siguientes cambios

1. La losa (Paso 5 en la letrina de pozo sencilla)
  - a. El recipiente debe ser fundido en la losa
  - b. Un orificio de inspección se debe crear en la losa por lo que el nivel de excretas en el pozo se puede controlar
  - c. El agujero de inspección no debe ser mayor de 0.25m de diámetro

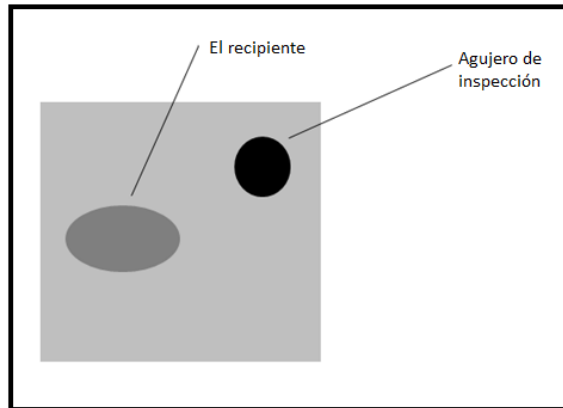

**Letrina con cierre hidráulico, paso 1**

2. El recipiente (Paso 5 en la letrina de pozo sencilla)

- a. El pan se puede comprar en una tienda de mejoras para el hogar (EPA) como de cerámica o de PVC de la unidad (preferiblemente)
- b. La bandeja de agua debe ser de 0,25 m por debajo de la losa

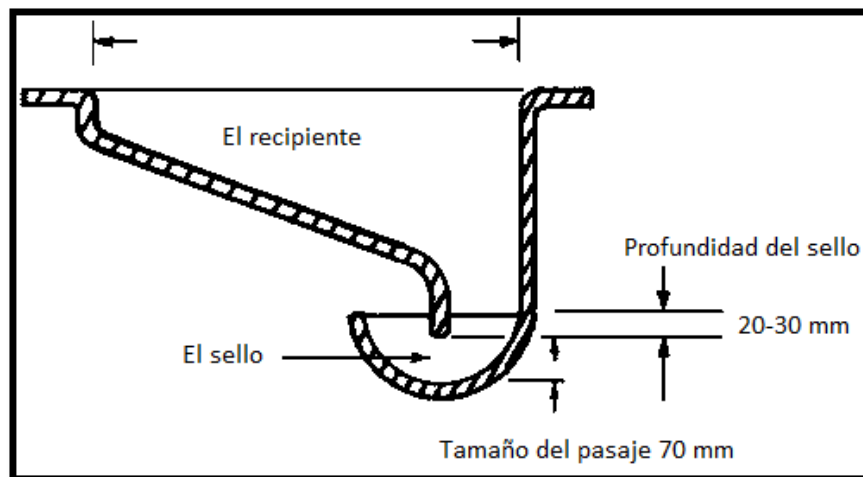

**La bandeja de agua (Imagen de la OMS, 1992)**

3. Mantenimiento (Paso 8 en la letrina de pozo sencilla)

- a. Ver letrina de pozo
- b. El agua debe mantenerse dentro de la letrina para el lavado
- c. El nivel del contenido de pozo debe ser revisado mensualmente
- d. Si el hoyo es temporal, debe ser cubierto cuando el nivel de excretas alcanza 0,5 m de la superficie del suelo

- e. Los productos de papel se deben recoger por separado de los desechos humanos para evitar la obstrucción de la bandeja de agua
4. Diseño alternativo:
- a. Un pozo doble letrina con cierre hidráulico
    - i. Una letrina de pozo doble requiere una caja de conexiones
      - 1. Se desvía el flujo de residuos a cualquiera del pozo (uno de los boxes de salida debe ser bloqueado)
      - 2. Permite el acceso para limpiar cualquier obstrucción en la tubería de desagüe o una trampa.
  - b. El tubo de desagüe
    - i. Es necesario si la fosa se compensa y no directamente por debajo de la losa de cubierta.
    - ii. Debe ser colocado con una inclinación de  $15^\circ$  a la horizontal
    - iii. Se debe tener un diámetro de 0,1 m
    - iv. Tubería de PVC se puede utilizar y debe ser enterrado para que no se expone al calor del sol
    - v. El extremo de la tubería debe extenderse por lo menos 0,1m en el pozo

Una letrina con cierre hidráulico doble es una estructura permanente. Se compone de dos letrinas de pozo y tiene el mismo concepto que una letrina de compostaje. Un pozo se utiliza a la vez y una vez que esté completo, ese pozo se deberá cerrar por lo menos dos años, que permite que los residuos se descompongan y los patógenos mueran. El compost puede ser vaciado mecánica o manual y se utiliza como fertilizante o acondicionador del suelo. El pozo se puede volver a utilizarse. La diferencia entre una letrina con cierre hidráulico y una letrina de compostaje es que el pozo en el que los residuos se es resistente al agua El agua puede ser añadido a la letrina a ras debido a que el revestimiento del pozo es perforado, por lo tanto, las aguas residuales pueden filtrarse a través del suelo.

## Letrina de Compostaje:

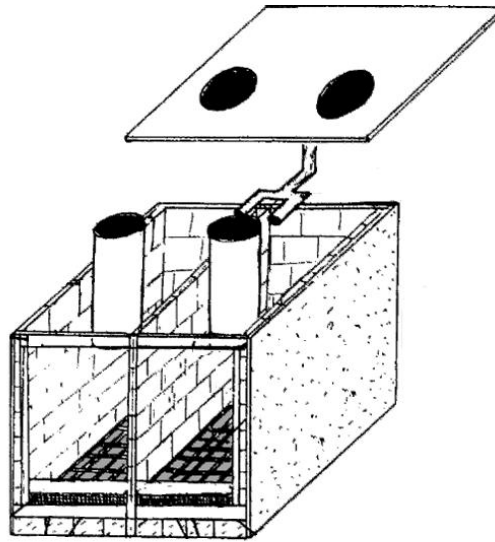

### Letrina de compostaje (Imagen por Clivus Multrum, Inc., 1994)

Una letrina de compostaje es un baño seco que funciona sin la adición de agua para el lavado. Es el más adecuado para las áreas que tienen una cantidad limitada de agua o donde el manto acuífero está muy lejos de la superficie del suelo. Residuos orgánicos pueden y deben ser agregados para ayudar a descomponer los excrementos en la letrina de compostaje. Después de cada uso, residuos secos, como cenizas o aserrín se agrega para ayudar a reducir los olores y absorber el contenido de agua de los excrementos. Cuando la primera bóveda está llena, se cubre durante por lo menos dos años y se utiliza la segunda bóveda. Una letrina de compostaje por lo general consta de dos bóvedas, con sólo una habilitada a la vez. Mientras que la segunda está en uso, los excrementos se descomponen en la primera bóveda y los patógenos mueren, y como resultado, se crea el compost. El compost de la primera bóveda se puede utilizar como fertilizante y acondicionador de suelos. Las aguas negras no pueden ser eliminados en la letrina de compostaje: si está presente, el proceso de descomposición se estropeará, causando problemas de olores y previniendo la descomposición adecuada. No hay necesidad de construir una letrina de compostaje nueva porque el compost se ha eliminado. Una letrina de compostaje es más cara y más difícil para construir en comparación con una letrina de pozo o una letrina con cierre hidráulico, pero puede ser construida como una estructura permanente. Letrinas de compostaje

requieren mantenimiento para asegurar que funcionen correctamente (Wolfgang, Berger 2010; WHO, 2005).

<b>Información Básica</b>	
Coste medio de implementación	€98.000-280.000 CRC
El coste medio anual de mantenimiento	€3.300-9.800 CRC
Facilidad de implementación	Mediana
Facilidad de mantenimiento	Fácil
Eficiencia	Las moscas y los olores no están presentes si el sistema se mantiene seco, el lodo es esterilizado si se deja en el pozo de compostaje más de dos años
Tamaño	Aproximadamente 6 m <sup>2</sup> de área, 1m de profundidad y 2m de altura
Duración de vida	10-20 años

<b>Ventajas</b>	<b>Desventajas</b>
No requiere entrada de agua (por lo tanto, reduce el consumo de agua)	Requiere un sistema separada para la eliminación de aguas grises
Los residuos no requiere tratamiento adicional	Olores y moscas si es mantenido adecuadamente
Puede estar utilizada para deshacerse de los residuos orgánicos (por lo tanto reduce el volumen de los residuos sólidos)	Si el compost no está maduro, requiere de contacto con desechos sólidos para limpiar la letrina
Estructura permanente	
Requiere mantenimiento diario	

<b>Limitaciones</b>
Sólo es adecuado en las comunidades donde el compost es un recurso útil
Tiene que estar implementado en un área donde la capa freática este al menos 2m del fondo del pozo durante la época lluviosa y no debe penetrar en las aguas subterráneas
Tiene que estar construido por lo menos a 30m del pozo
Tiene que estar construido por lo menos a 30m del río
Tiene que estar construido alrededor de 5m de la casa
Debe estar construido cuesta abajo de la fuente de agua

Construcción:

1. Cavar un pozo de 2,4m de largo, 2,0m de ancho y 0,5 a 1,0m de profundidad, con un área para un tubo de ventilación

- a. Un área pequeña de un tubo de ventilación tiene que estar construido fuera de la parte larga del pozo, 0,25m por 0,25m
- b. El agua no puede estar en el pozo
- c. Si el agua subterránea está cerca de la superficie del suelo, este pozo puede ser construido a partir de materiales impermeables de hormigón o de otro tipo sobre la tierra. En este caso, un suelo impermeable debe ser construido en el pozo.
- d. El piso de concreto debe ser de 50 a 70mm de grueso

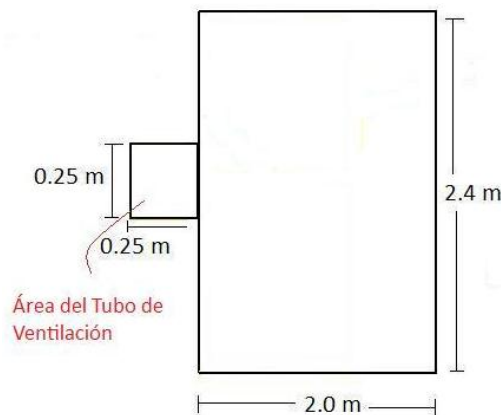

**Vista aérea de la letrina de compostaje, Paso 1**

2. Construir una pared de separación y una línea del pozo
  - a. Una pared de separación debe ser construida de 1,2m en el lado largo del pozo
  - b. La línea del pozo y la pared de separación deben ser construidas con bloques de hormigón o ladrillos de barro cocido, mortero de cemento, y estar a 0,8m sobre la superficie de la tierra (haciendo el pozo de 1,3m-1,8 m de profundidad)
  - c. Forrar por dentro las paredes del pozo y el tubo de ventilación. La cantidad de material necesario para forrar el pozo depende de su tamaño:
    - i. Para un pozo de 2,4m de largo, 2,0m de ancho y 1,6m de profundidad, con un 0,25m por 0,25m área de tubería de ventilación, sin piso de cemento, con una pared de separación, se requiere  $Xm^2$ :
    - ii.  $2(2.4 m \times 1.6) + 3(2.0 m \times 1.6m) + 3(0.25 m \times 1.6m) = m^2$

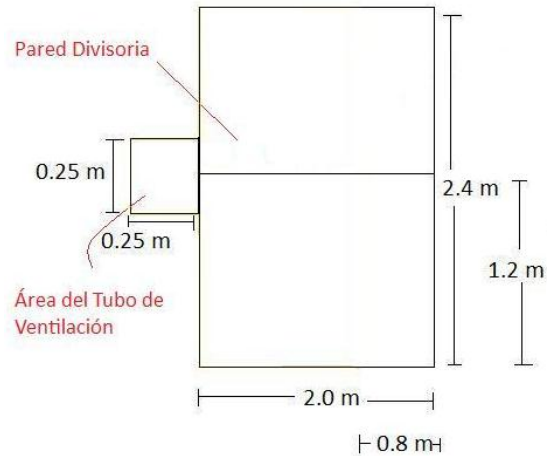

**Vista aérea de la letrina de compostaje, paso 2**

3. Viga de apoyo

- a. Construir una viga de apoyo de madera tratada que sea de 0,8m de lado sin el tubo de ventilación. Debe ir a través de la pared de separación, en paralelo al lado largo del pozo.

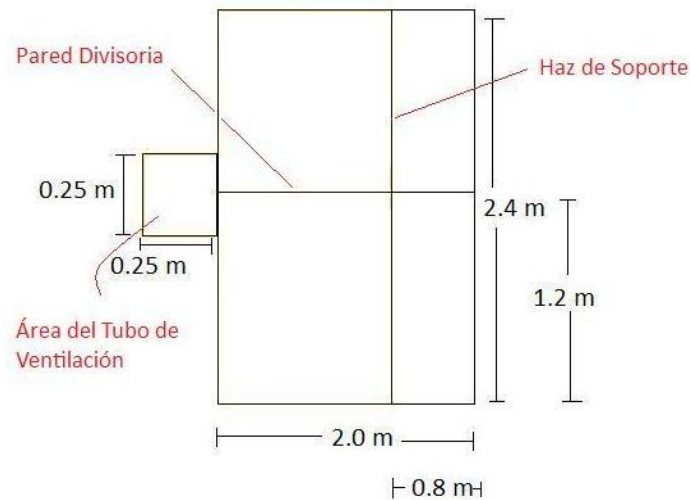

**Vista aérea de la letrina de compostaje, Paso 3**

4. Apoyo para la losa

- a. Construir paredes alrededor del área del tubo de ventilación, el área grande, y la pared de separación adentro del área grande (como se muestra en la Figura 19, denotada en amarillo) con 0,15m de material para forrar (hormigón o ladrillo). No



haga la pared de separación entre el área del tubo de ventilación y el pozo más alto de lo especificado para permitir ventilación.

- b. Losas eyacular colocará sobre este área construido. La parte inferior es para el vaciado y la visualización del pozo.

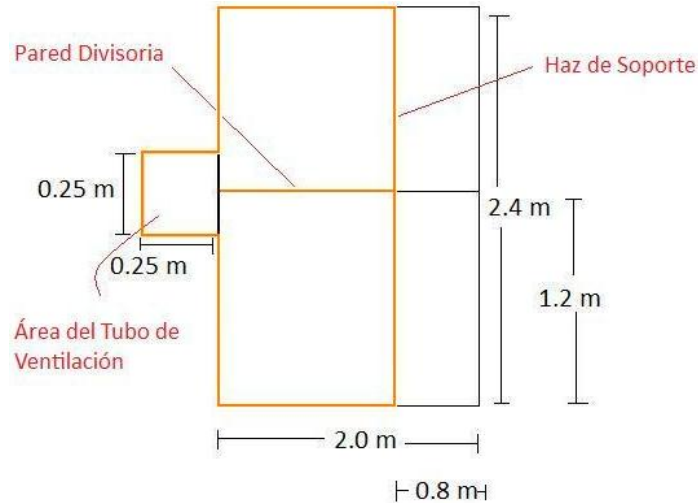

**Vista aérea de la letrina de compostaje, Paso 4**

#### 5. Losa de Cuclilla

- a. Ver letrina de pozo sencilla
- b. La losa cuclilla para la letrina de compostaje debe cubrir los dos pozos y tiene dos agujeros para permitir el paso de desecho en el pozo.
- c. La losa sirve de soporte para el usuario, cubre el pozo, y previene el ingreso de animales en el pozo. Por esta razón, la losa debe ser ligeramente más grande que el pozo.
- d. La losa debe ser construida de concreto
- e. La losa debe tener un agujero por el cual pueda pasar el excremento hacia el pozo
- f. La losa debe de ir inclinada hacia el pozo para permitirle a los desechos caer en el.
- g. La apertura debe ser menor a 0,25m en cualquier dirección para prevenir que un niño caiga en el pozo.
- h. La losa puede tener un asiento construido en la parte superior del agujero para la comodidad del usuario o bien el usuario puede ponerse en posición de sentadilla sobre el agujero

6. La tapa

- a. Ver letrina del pozo sencilla

7. Chimenea de ventilación

- a. El área de ventilación debe ser construido con ladrillos o bloques de hormigón hasta que es tan alto como el albergue (Figura 20). La parte superior de la chimenea de ventilación debe ser cubierto con malla de alambre para evitar que los materiales caigan en el pozo. Un pequeño techo de madera o estaño debe estar agregado para evitar que la lluvia va por la chimenea.

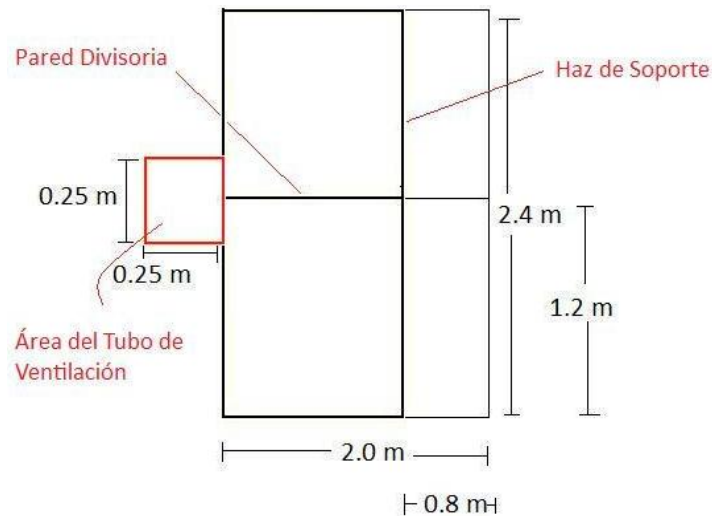

**Vista aérea de la letrina de compostaje, paso 7**

8. El albergue

- a. Ver letrina del pozo sencilla

9. Mantenimiento

- a. Ver letrina del pozo
- b. Los residuos orgánicos deben de ser agregados a la letrina semanalmente, o aún mejor diariamente.
  - i. Esto ayuda a descomponer los excrementos y resulta en un mejor compost
- c. Desechos secos, como el aserrín y las cenizas, deben ser agregados a la letrina después de cada uso
  - i. Esto reduce el olor y resulta en un mejor compost

- d. Cuando la bóveda está llena (0,5m de la losa), la bóveda debe ser sellada y la otra bóveda debe ser utilizada. La bóveda llena debe permanecer sin utilizar por dos años para permitir que los excrementos completen su descomposición. Después de dos años, el excremento no contendrá agentes patogénicos. Debe de estar seco y sin olor. Si es así, se puede ser utilizado como fertilizante.

## Letrina de Compostaje con Desviación de Orina

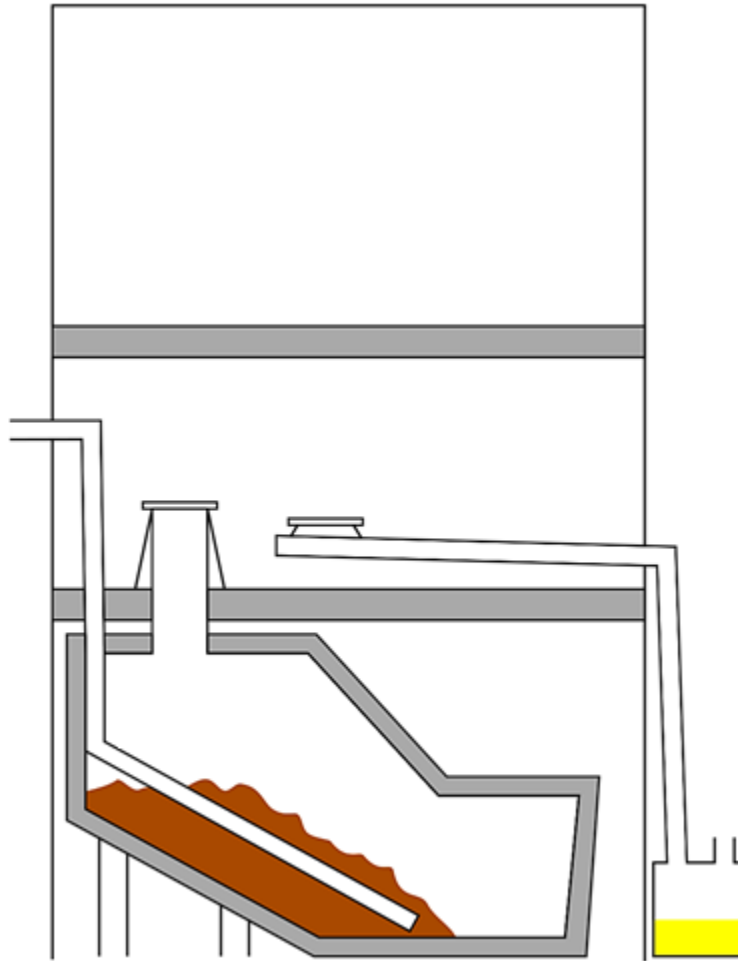

Letrina de compostaje con desviación de orina (Imagen de Clivus Multrum, Inc., 2010)

Las letrinas de compostaje en su presentación más eficiente, pueden presentar una desviación de orina. Las letrinas de compostaje con desviación de orina también se conocen como baños secos con separación o UDDT (por sus siglas en inglés). El beneficio de una letrina de compostaje con desviación de orina es que reduce la cantidad de producción de lixiviados, lo que significa que hay menos necesidad de agregar arena para absorber el agua. En la Figura 4, la letrina de compostaje divide las heces de la orina en dos recipientes separados. Las letrinas de compostaje requieren mantenimiento para asegurar su correcto funcionamiento (Wolfgang Berger 2010).

<b>Información Básica</b>	
Coste medio de implementación	∅105.000-300.000 CRC
El coste medio anual de mantenimiento	∅3.300-9.800 CRC
Facilidad de implementación	Mediana
Facilidad de mantenimiento	Fácil
Eficiencia	Las moscas y los olores no están presente si el sistema se mantiene seco, el lodo es esterilizado si deja en el pozo de compostaje más de dos años
Tamaño	Aproximadamente 6 m <sup>2</sup> del área , 1m de profundidad y 2m de altura
Duración de vida	10-20 años

<b>Ventajas</b>	<b>Desventajas</b>
No requiere entrada de agua (por lo tanto, reduce el consumo de agua)	Requiere un sistema separado para la eliminación de aguas grises
Los residuos no requieren ningún tratamiento adicional	La presencia de olores y moscas se dan si no se mantiene adecuadamente
Puede estar utilizado para deshacerse de los residuos orgánicos (por lo tanto reduce el volumen de los residuos sólidos)	Requiere de contacto con el excremento si el compost no está maduro
Estructura permanente	Puede ser difícil de utilizar para todas las personas.
Requiere mantenimiento diario	
Al haber menos entrada de líquido que los sanitarios de compostaje estándar, los residuos se descomponen más rápido y se produce un compost de alta calidad produce	

<b>Limitaciones</b>
Sólo es adecuado en las comunidades donde el compost es un recurso útil
Debe ser implementado en un área donde la capa freática es al menos 2m del fondo del pozo durante la temporada de lluvias y no debe penetrar en las aguas subterráneas
Debe ser construido por lo menos 30m del pozo
Debe ser construido por lo menos 30m del río
Debe ser construido alrededor de 5m de la casa
Se debe construir a desnivel de la fuente de agua, para evitar la contaminación de la misma.

### **Construcción**

Lo mismo como la letrina de compostaje con las siguientes modificaciones

1. La orina es desviada del interior de la letrina en un recipiente fuera de la letrina

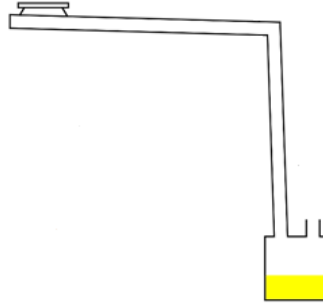

### **Letrina de compostaje con desviación de orina, paso 1**

2. Una bandeja de PVC puede estar instalada en una caja de madera. Esta estructura estará conectado por tubos de PVC a través de la pared de la vivienda en un recipiente fuera de la letrina.
3. La orina debe ser eliminada a diario. Una mezcla de 1 parte de orina y 3 partes de agua puede estar utilizado para regar las plantas.

## Sistema de tanque séptico:

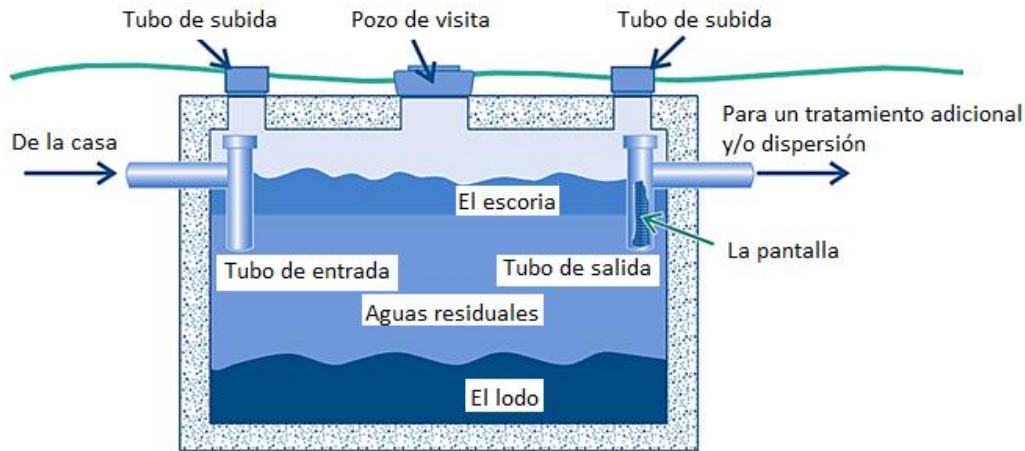

**Esquema de una cámara de tanques sépticos (Imagen de la Agencia de Protección Ambiental de Estados Unidos, 2002)**

Un sistema séptico es una opción para el manejo de los desechos corporales humanos. Dicho sistema está conformado por un tubo que abastece de agua a la residencia, un tanque séptico, un campo de drenaje y el suelo. Todas las aguas residuales son transportadas desde la residencia a la fosa séptica por un tubo. Un tanque séptico es un gran contenedor en el que se recogen las aguas residuales y descompuestas por las bacterias anaeróbicas. Es impermeable y por lo general subterráneo. Las partículas de residuos sólidos se depositan en el fondo de la fosa séptica, conocido como lodo, mientras que la grasa se aloja en la parte superior del tanque, también conocido como escoria (Figura 7). El efluente puede ser bombeado desde el tanque séptico en el campo de drenaje, donde es tratado por el suelo a través de la filtración. Sin embargo, el efluente es sólo parcialmente tratado y en él se contienen agentes patógenos. Los tanques sépticos requieren la eliminación de rutina de los lodos y espuma, por lo general cada dos a cinco años. Si el lodo y la basura no se quitan, se puede producir desbordamiento e inundación de la propiedad con aguas residuales sin tratar. Dicho desbordamiento es muy costoso de limpiar y puede resultar en efectos adversos para la salud, como la hepatitis y otras enfermedades producidas por el contacto con material fecal. Debido al riesgo de desbordamiento, el seguimiento anual es necesario. Un tanque séptico micro, opera del mismo modo que un tanque séptico normal, pero es mucho menor y pueden un volumen menor de aguas residuales. Por esta razón, sólo se usan para tratar aguas negras. Se debe vaciar cada uno o dos años. Para determinar el tamaño de un tanque séptico, se debe de consultar a un experto que además pueda

brindar consejos sobre su construcción (Frenoux, 2011; de los Estados Unidos la Agencia de Protección del Medio Ambiente, 2002).

<b>Información Básica</b>	
Coste medio de ejecución	¢262.000-525.000 CRC
El coste medio anual de mantenimiento	¢3.300-6.600CRC
Facilidad de implementación	Difícil
Facilidad de mantenimiento	Facil
Eficiencia	No hay moscas ni olores presentes, en parte trata las aguas residuales
Tamaño	Al menos 5m <sup>2</sup> de espacio disponible para el depósito, de unos 30 m <sup>2</sup> de campo de drenaje
Duración de vida	10-20 años

<b>Ventajas</b>	<b>Desventajas</b>
Bajos costos de operación	Requiere el vaciado regular por un profesional
Trata tanto de aguas negras y aguas grises	Alto costo de inversión
	Efluente requiere tratamiento secundario
	Requiere una fuente constante de agua
	Requiere una gran superficie de terreno para campo de drenaje

<b>Limitaciones</b>
Debe ser implementado en un área en la que un profesional del servicio de vaciado del tanque séptico está disponible
Se debe implementar en una comunidad que no está en riesgo de inundaciones
Deben ser implementadas en una comunidad que tiene métodos para el tratamiento de efluentes más o transportar los efluentes fuera del sitio a tratar
Debe ser construido por lo menos 30 m de la fuente de agua
Se debe construir hacia abajo de la fuente de agua

### **Construcción:**

Las siguientes instrucciones son para la construcción de un tanque séptico de dos cámaras. Los individuos que construyan el sistema debe tener el conocimiento para trabajar con concreto. Un profesional debe ser consultado. La instalación incorrecta de un tanque séptico puede dar lugar a aguas residuales sin tratar se filtran en el suelo, causando malos olores y contaminación de aguas subterráneas.



1. Calcular el volumen requerido
  - a. El volumen del tanque debe ser de 3 veces el volumen de aguas residuales del hogar puede producir diario
  - b. El volumen del tanque debe ser de  $1,5 \text{ m}^3$  con un aclaramiento de  $0,3 \text{ m}$  sobre el nivel de las aguas residuales para dar cabida a un mínimo de desbordamiento
2. La construcción del tanque de
  - a. El tanque debe ser excavado en el suelo:  $1,5 \text{ m}$  de longitud,  $1,5 \text{ m}$  de ancho y  $1,8 \text{ m}$  de profundidad

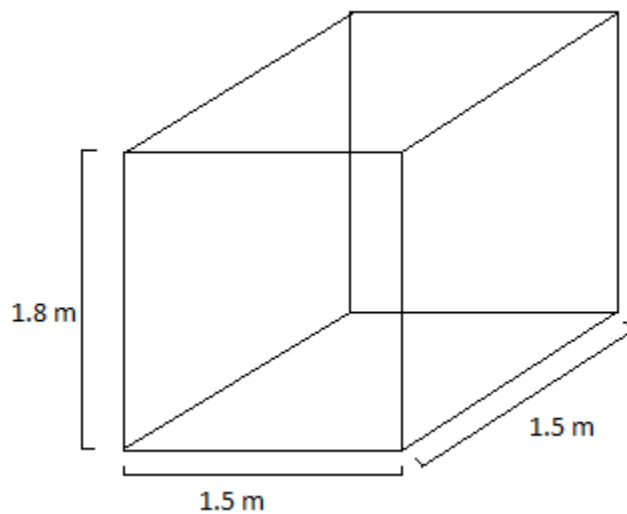

**Sistema séptico, paso 2a**

- b. Un muro de separación debe ser construido de manera que  $2 / 3$  del volumen total está en un lado de la pared, y el restante  $1 / 3$  en el otro.
        - b.i. Esta pared debe ser construida a lo largo de  $0,5 \text{ m}$  ya sea del lado del pozo

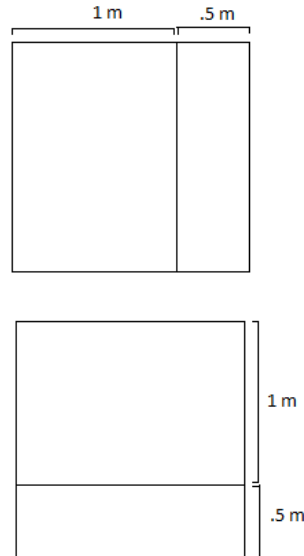

### Sistema séptico, paso 2b

- b.ii. Que debe ser construido de hormigón o ladrillo
- b.iii. Tiene que haber un tubo entre las dos cámaras. Esto permite que los efluentes de pasar de la cámara grande a la pequeña. El agujero debe estar en el centro de la pared divisoria.
- c. Debe haber dos tubos en forma de T en el tanque séptico. Uno colocado cuando las aguas son vertidas y otro para poder llevar las aguas al campo de drenaje. Son en forma de T para evitar suciedad y el bloqueo por medio del lodo de los flujos de aguas residuales. Las tuberías de aguas residuales para permitir el flujo en el tanque y los efluentes a salir del tanque. Estos tubos son normalmente de 0,1 m de diámetro y de PVC.
  - c.i. Una tubería lleva las aguas residuales de la residencia al tanque séptico. El otro lleva efluente del tanque en un campo de drenaje.

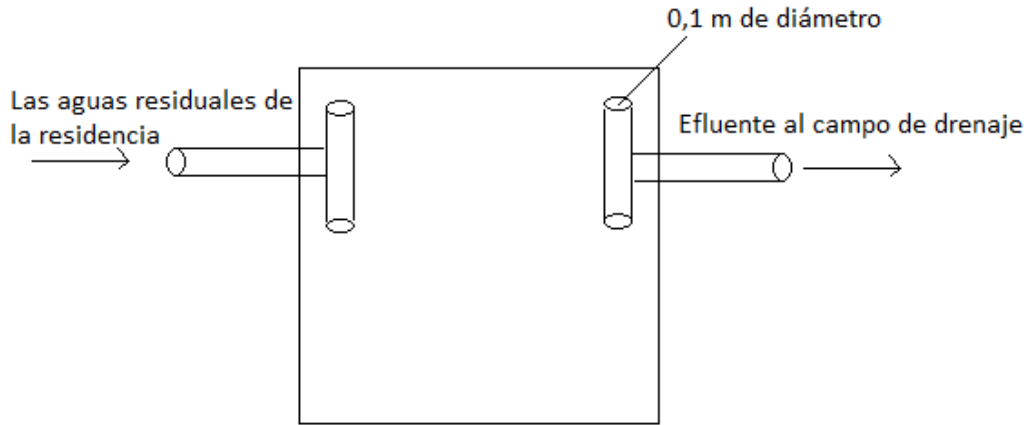

**Sistema séptico, paso 2c**

- d. Todas las paredes deberán estar construidas con concreto o ladrillos. Se debe de tener una impermeabilidad a lo largo de la pared, incluyendo el área alrededor de cada tubo. Esto se puede lograr con cemento.

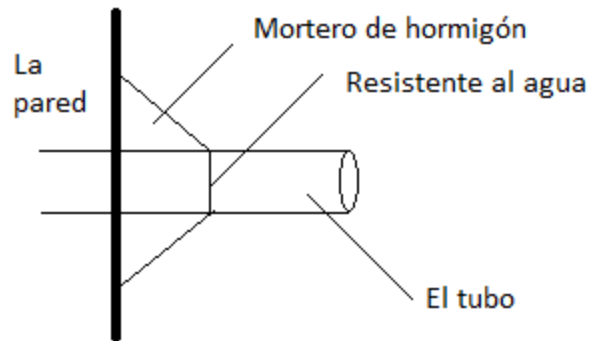

**Sistema séptico, paso 2d**

- e. Una tapa hecha de concreto debe cubrir todo el tanque, con un orificio de inspección que permita ver las dos cámaras. También debe haber un ventilador encima de la cámara grande para permitir que el gas escape del tanque. Esto puede hacerse de tubo de PVC con cedazo en la parte expuesta al ambiente para evitar que los insectos entren en el pozo y un pequeño techo para evitar que la lluvia entre en el hoyo. La tubería de PVC debe ser de 0,05 m de diámetro

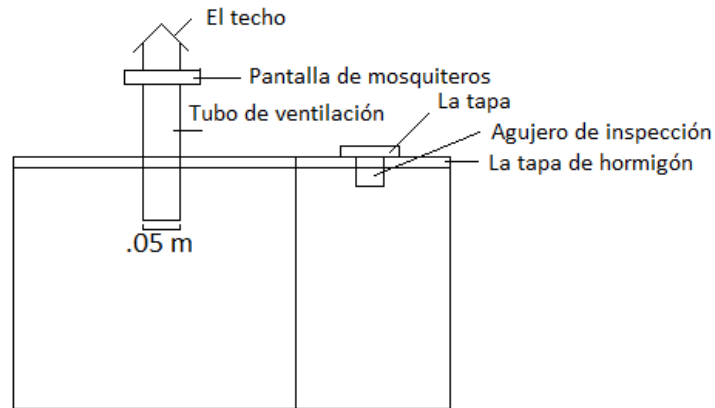

**Sistema séptico, paso 2e**

3. Evacuación de efluentes

- a. Los lodos se hunden hasta el fondo del tanque y la espuma flotan en la superficie. El efluente se bombea a un campo de drenaje o pozo seco.

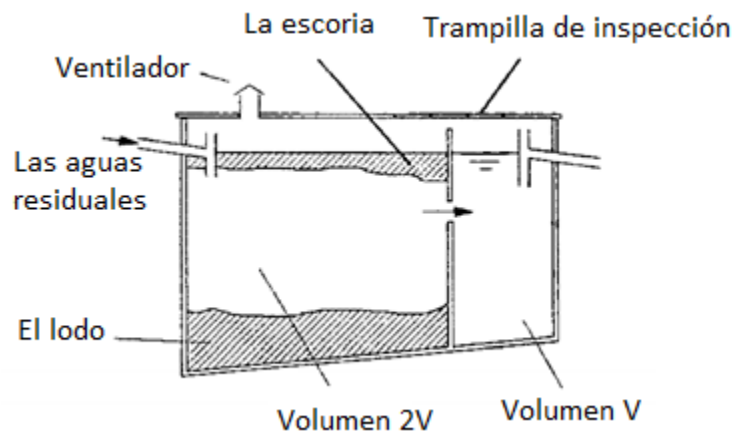

**Sistema séptica con dos cámaras (OMS, 2005)**

- b. Construir una fosa de percolación para disponer de los efluentes: Ver Fosa de percolación

4. Mantenimiento

- a. Un tanque séptico debe ser inspeccionado al menos una vez al año para ver si está lleno. Cada tres a cinco años, debe ser vaciado de los lodos. Esto debe ser hecho por una empresa de limpieza profesional séptico con una bomba de succión y la cisterna.

## Humedales Construidos

Humedales construidos, también conocida como carrizales, biojardines y lagunas de estabilización, se refiere a que el agua fluya a través de la vegetación poco a poco, y se de la filtración de sólidos en suspensión. Los microorganismos que viven en los humedales degradan otros contaminantes en el agua, como nitrógeno y fósforo. Las plantas utilizadas son originarias de la ubicación en que el humedal se construye. Aguas grises y aguas negras tratadas previamente, como efluente del tanque séptico, pueden ser tratadas por los humedales construidos (DuPoldt, 1994; United States Environmental Protection Agency, 2004). Los humedales construidos se componen de un filtro para atrapar partículas grandes, una trampa de grasa para eliminar aceites, una laguna anaerobia más de 2,5m de profundidad para eliminar los sólidos y materia orgánica, una laguna facultativa entre 1-2 m de profundidad para eliminar los agentes patógenos, y una laguna de maduración entre 1 - 2 m de profundidad para completar el tratamiento.

Los humedales construidos son menos caros para construir que las otras opciones de tratamiento de aguas residuales y para tolerar las fluctuaciones en el volumen de aguas residuales. Un humedal construido permite que el agua fluya por encima o por debajo de la superficie de la canal. Hay dos tipos de humedales construidos: el flujo de superficie, donde las aguas residuales fluyen en la parte superior de la tierra en el canal, y el flujo subterráneo, donde las aguas residuales fluyen a través de un medio poroso, como la grava, en el canal. El canal está lleno de arcilla o forro sintético y cubierta de piedras y tierra. La vegetación acuática nativa entonces está plantada en el canal. Las aguas residuales se vierten en el canal y filtran los sólidos de los humedales construidos y elimina las impurezas orgánicas, como el nitrógeno y el fósforo.

<b>Información Básica</b>	
Costo medio de implementación	¢16.000- 39.300CRC
El costo medio anual de mantenimiento	¢3.300-6.600 CRC
Facilidad de implementación	Mediana-difícil
Facilidad de mantenimiento	Fácil
Eficiencia	No hay moscas ni olores, trata las aguas residuales
Tamaño	1 m <sup>2</sup> por persona, el estanque más profundo es de 2,5 m de profundidad
Duración de vida	25-50 años

<b>Ventajas</b>	<b>Desventajas</b>
Bajos costos de operación	El lodo requiere un tratamiento secundario
Trata aguas negras y grises pretratados	Alto costo de inversión
Es eficiente en la eliminación de patógenos	Largo tiempo de inicio
Tolera las fluctuaciones en el volumen de aguas residuales	Requiere un gran área de tierra
Estéticamente agradable, proporciona soporte de los animales por el hábitat	Requiere un mantenimiento regular de las plantas
Material poroso puede ser creado a partir de materiales reciclados (los chips de los neumáticos)	Requiere un monitoreo semanal para determinar cuándo los humedales o la trampa de la grasa debe ser limpieza de materiales
	Puede facilitar la reproducción de los mosquitos

<b>Limitaciones</b>
Debe ser construido por lo menos a 30 m de la casa
Se debe implementar una opción de tratamiento secundario para el lodo que se acumula en el humedal
Se debe implementar en un área que se inunda con una frecuencia menor de una vez cada 100 años

## **Construcción**

El diseño y planificación de los humedales construidos debe ser realizado por un profesional. La colocación de los humedales depende del área específica en la que se construirá. La construcción puede ser realizada por miembros de la comunidad. Sin embargo, no se puede realizar de forma manual. Requiere el uso de una retroexcavadora.

1. Selección de la tierra
  - a. El pH de la tierra debe estar entre 6,5 y 8,5: pH afecta a la capacidad de la tierra para retener los residuos.
  - b. La arena debe ser evitado debido a la falta de nutrientes para las plantas, y la arcilla no debe estar utilizada, porque inhibe el crecimiento de las plantas.
  - c. La tierra debe contener materia orgánica para que las plantas acuáticas pueden florecer en el humedal. Esto se puede lograr mediante por la adición de compost o lodos de aguas residuales a la tierra. La arena puede ser utilizada si se complementa con la materia orgánica.
2. Selección de plantas

- a. Las plantas ideales para los humedales construidos son juncos, spikerush, cañas, y espadañas. No todas las especies que están presentes en los humedales naturales son apropiados para los humedales construidos debido a la exposición de las aguas residuales.
    - i. Estos son de los géneros *Scripus*, *Efeocharis*, *Cyperus*, *Juncus*, *Phragmites* y *Typha*.
  - b. Las especies nativas deben estar utilizadas porque se han adaptado al clima local y las plagas
  - c. Junco (*Scripus*) es la mejor opción a menudo, porque no es invasivo, tiene rápido crecimiento y debido a la tolerancia de sus materiales en las aguas residuales
  - d. Las plantas deben ser completamente desarrolladas antes de que se utilicen para tratar los residuos
  - e. El humedal debe incluir una variedad de plantas y deben ser plantadas densamente
3. La selección de un sitio
    - a. El sitio no debe estar en un área que se inunda más de una vez en 100 años
    - b. La selección de un humedal construido debe ser llevada a cabo por un profesional certificado en la asignación de los humedales
    - c. El humedal deberá ser construido en un área de terreno nivel
  4. Dimensionamiento de los humedales
    - a. El tamaño del humedal depende en el número de personas dependientes en el sistema, el volumen de residuos que las personas producir, la cantidad de tratamiento necesario para la eliminación de contaminantes, y la tasa de infiltración del suelo
    - b. La relación entre longitud y anchura debe ser 1:1 y 10:1

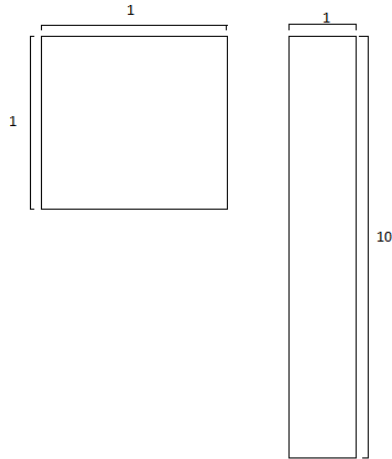

### Humedales construidos, paso 4b

- c. La laguna de maduración requiere  $1 \text{ m}^2$  por cada residente.
  - i. Para una comunidad con 200 habitantes, un estanque de maduración de  $200 \text{ m}^2$
- d. El tamaño de la laguna anaerobia depende en el tamaño de la laguna de maduración. debe ser el 1% -5% del tamaño de la laguna de maduración. Por ejemplo, un estanque de maduración de  $200 \text{ m}^2$  garantiza una laguna anaerobia que es de  $2\text{-}10 \text{ m}^2$ .

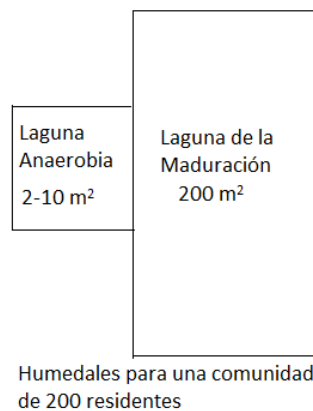

### Humedales construidos, paso 4d

- 5. La construcción de bermas
  - a. Bermas evitan el agua que entran o salen del humedal



- b. Por lo general son construidas 0,6-1m sobre el nivel del agua en el humedal, con pendientes de 35°-55°. Se deben ser tan alta como sea necesario para evitar el agua de pluviales de escurrimientos de entrar en el humedal

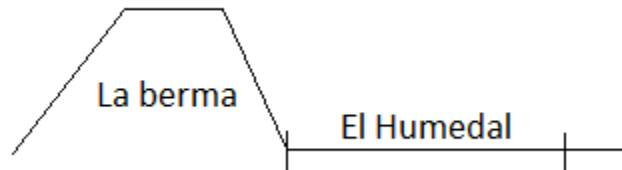

### Humedales construidos, paso 5

- 6. La trampa de grasa
  - a. Una trampa de grasa debe ser instalado para evitar que la grasa y el aceite de entrar en el humedal
  - b. Una trampa de grasa puede ser creado a partir de un barril de 55 galones. Las aguas grises de la casa se deposita en el tanque en la parte superior. La grasa flota en la superficie y el resto de las aguas grises sale del tanque por un agujero en el fondo
  - c. La grasa puede ser removido de los efluentes de las fosas sépticas en la misma manera
  - d. Grasa, aceite y grasa debe ser removida de la parte superior del barril semanal

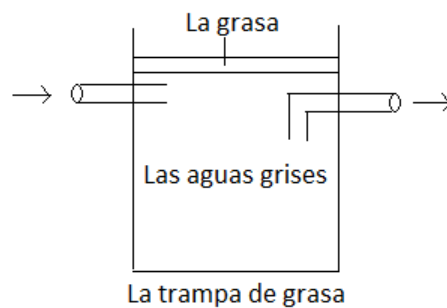

### Humedales construidos, paso 6

- 7. La construcción del humedal
  - a. Excavar el área de la laguna anaerobia, según lo determinado en el paso 4
  - b. Línea la fosa con arcilla o revestimiento sintético, como una línea de PVC

- c. Excavar una zanja de la fuente de las aguas residuales a la laguna anaerobia para la tubería de entrada que disminuye ligeramente hacia el estanque para permitir que los aguas residuales fluya por gravedad



**Humedales construidos, paso 7c**

- d. Coloque el tubo de entrada, hecha de PVC, en la zanja y cubierta con tierra

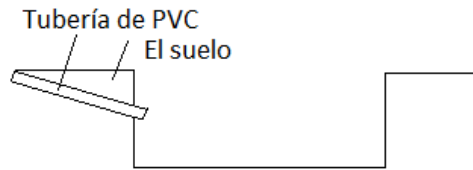

**Humedales construidos, paso 7d**

- e. Llene el pozo con grava, relleno con tierra y hacer nivel
- f. Cavar una zanja de la laguna anaerobia a la laguna de maduración o en la zanja de percolación (ver la zanja de percolación) y poner el tubo de salida de PVC en la zanja y cubierta con tierra

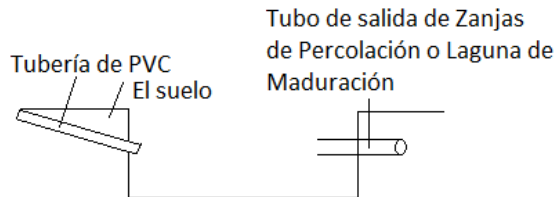

**Humedales construidos, paso 7f**

- g. Prueba de los humedales por llenarlos con agua limpia, la detección de fugas y que el sistema fluya adecuadamente
- h. Agregar plantas acuáticas

## 8. Mantenimiento

- a. Mantenimiento varía ligeramente en función del tamaño calculado de los humedales y la composición de las aguas residuales
- b. Las tuberías de entrada y salida se deben limpiar de vez en cuando para eliminar los residuos
- c. El nivel del agua debe ser constante. Cambios en el nivel del agua puede ser debido a fugas en las paredes, tuberías obstruidas, o bermas violadas
- d. Los humedales construidos no requieren mantenimiento con respecto de vegetación, a menos que las plantas crecen muy poco. En ese caso, la vegetación debe ser replantados
- e. Depredadores de mosquitos, como el pez mosquito y las libélulas, debe añadirse a los humedales, si la reproducción de mosquitos se convierte en un problema

## El Pozo Seco

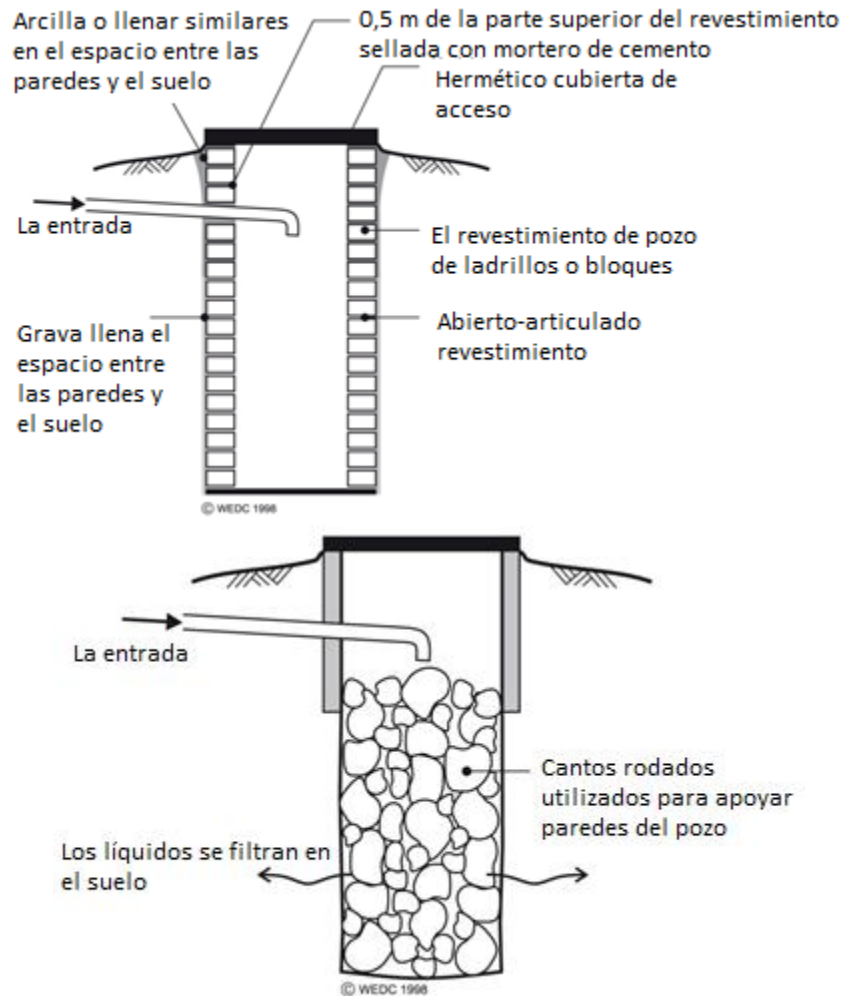

### **Seco letrina (Imágenes cortesía de WEDC © Varilla Shaw 2002).**

Un pozo seco, también conocido como un pozo o pozo de absorción, consiste en un pozo lleno de grava o un pozo revestida con material poroso que permite que las aguas residuales se filtren en el suelo. Este es el más adecuado para un área donde el suelo permite la infiltración del agua con facilidad. Los pozos secos se utilizan solamente para aguas grises o aguas residuales pretratadas. El hoyo debe ser colocado por encima del agua para que se mantenga seco. Luego de esto, las aguas residuales se vierten directamente en este pozo, donde se filtran a través de la grava y el suelo. Para deshacerse de las aguas grises en un pozo seco es útil la reducción del volumen de aguas residuales en exceso en la tierra o en aguas superficiales. Los pozos secos se

deberán limpiar, si están obstruidos por materiales como la grasa y el jabón. Una trampa de grasa también se puede implementar para reducir la frecuencia de la limpieza (Frenoux, 2011).

Información Básica	
Costo medio de ejecución	¢20.000-39.300 CRC
El coste medio anual de mantenimiento	¢3.300-6.600 CRC
Facilidad de implementación	Fácil
Facilidad de mantenimiento	Fácil
Eficiencia	No hay moscas ni olores
Tamaño	1 m de diámetro y 2,5 m de profundidad
Duración de vida	3-5 años

Ventajas	Desventajas
Bajo costo de mantenimiento y operación	La obstrucción puede ocurrir
Fácil de construir	No es apropiado en climas fríos
Materiales fácilmente disponibles	Pre-tratamiento de las aguas negras se requiere
Requiere de pequeñas áreas de la construcción	Pueden contaminar las aguas subterráneas
Repone masas de agua subterránea	
Fácil de usar	

Limitaciones
El suelo debe ser permeable
No se deben construir en una zona con riesgo de inundación
Se deben construir por lo menos 30 metros de cualquier fuente de agua
La parte inferior del pozo debe ser construido a 1,5 metros sobre el nivel freático
No se debe utilizar en un área en la que grandes volúmenes de aguas residuales se producen diariamente

### Construcción:

#### 1. El pozo:

- a. El hoyo debe ser de 1 metro de diámetro y 2,5 m de profundidad (una casa). Ver Figura 38. Elija la Parte B o la Parte D.

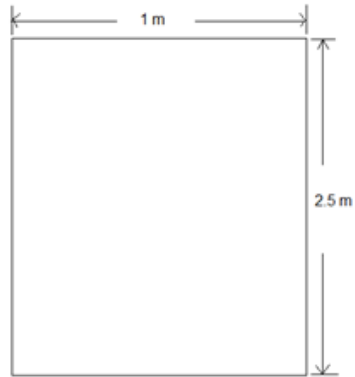

Vista lateral

**El pozo seco, paso 1a**

- b. Coloque 0,04 m de arena en el fondo y 0,04 m de grava sobre la arena.
- c. Llene el agujero con piedras. Ver Figura 39.

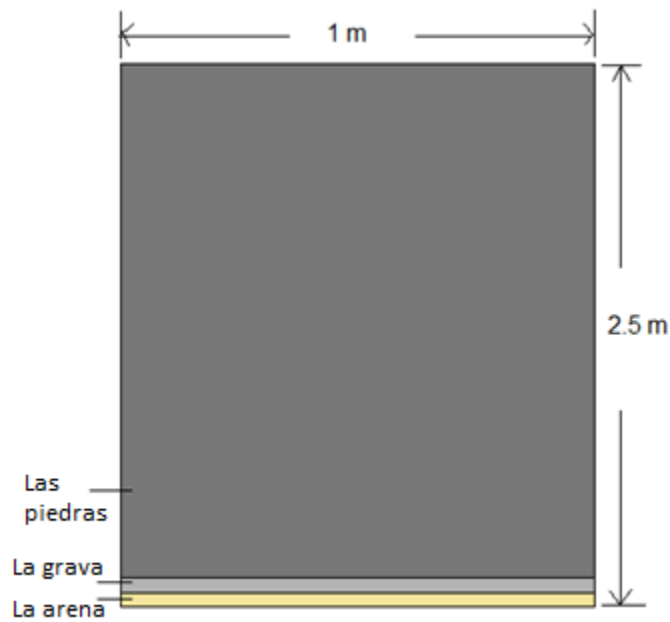

Vista lateral

**El pozo seco, pasos 1b, 1c**

- d. Alinear el agujero con el ladrillo. Ver Figura 40.

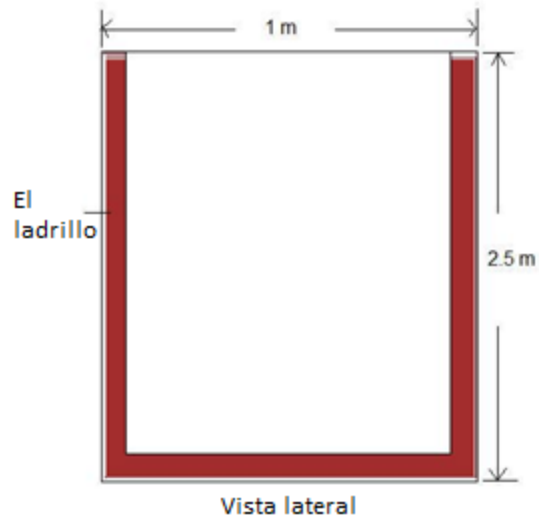

**El pozo seco, paso 1d**

2. La tapa

- a. El hoyo debe ser cubierto para evitar:
  - i. El pozo se derrumbe
  - ii. Entrada de moscas y otras alimañas en el pozo
- b. Asegúrese de que hay una abertura en la cubierta para mantenimiento. Ver Figura 41.
- c. La tapa debe ser de hormigón o bien compactada de arcilla o tierra



**El pozo seco, paso 2c**

3. La tubería

- a. La tubería de entrada deberá entrar en el pozo cerca de la cima

- i. Tubo de PVC de 0,1 m de diámetro se pueden utilizar. Ver Figura 39.

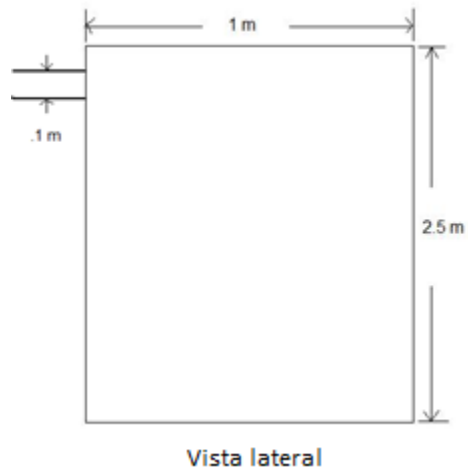

**El pozo seco, paso 3ai**

#### 4. Mantenimiento

- Los pozos secos se pueden abrir, limpiar y rellenar con las mismas rocas
- Las aguas residuales deben ser filtradas antes de entrar en el pozo seco para asegurarse de que no causen obstrucción (es decir, con una trampa de grasa)
- El pozo seco deberá mantenerse alejado de alto tráfico para que el suelo alrededor de la fosa no se compacte
- Debe ser adecuadamente limpiado, los lodos se acumulan con el fin de mantener la funcionalidad.



## Fosa de percolación

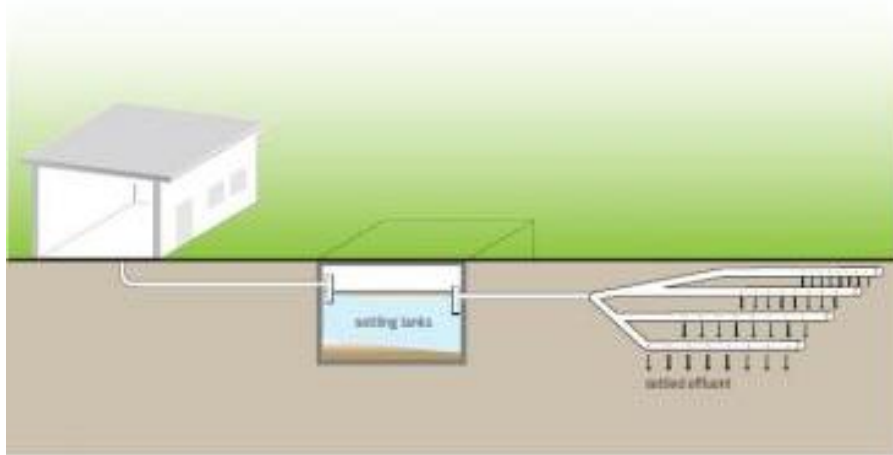

**Filtración De Campo (Imagen de Tilley, 2008)**

Zanjas de percolación, también conocido como zanjas de infiltración, se pueden utilizar para deshacerse de las aguas grises o aguas residuales pretratadas. Ellos tienen el mismo concepto que un pozo seco, que es el tratamiento de agua por percolación. El sistema consta de un canal poco profundo lleno de grava. De aguas residuales se filtran a través de la grava y el suelo a los lados y fondo de la zanja. Como pozos secos, zanjas de percolación no son apropiados para áreas en las que las inundaciones son comunes. Se puede combinar con un tanque séptico.

Las aguas residuales son conducidas por una tubería en las zanjas que consisten en tubos perforados establecidos en la parte superior y cubierta con grava. Las trincheras están cubiertas de la tela geotextil para evitar que la tubería se tape. El sistema es ideal para zonas donde el suelo es permeable.

Las zanjas deben estar ubicadas en una zona con un alto nivel freático y a por lo menos 30 metros de una fuente de agua potable. La zanja debe tener por lo menos 20 metros de largo y medir de 1 a 2 m de distancia. Así mismo, los usuarios deben estar informados sobre cómo funciona el sistema. Hay riesgos de salud a bajo porque los usuarios rara vez son expuestas a los efluentes.

<b>Información Básica</b>	
Coste medio de ejecución	€20.000-39.300 CRC
El coste medio anual de mantenimiento	€3.300-6.600 CRC
Facilidad de implementación	Difícil
Facilidad de mantenimiento	Fácil
Eficiencia	No hay moscas ni olores
Tamaño	20 m <sup>2</sup>
Duración de vida	10-20 años

<b>Ventajas</b>	<b>Desventajas</b>
Reducir las inundaciones locales	Requieren una inspección frecuente y mantenimiento
Habilidades de bajo nivel para el mantenimiento	Riesgo de obstrucción por sedimentación frecuentes
Puede ser utilizado para el tratamiento combinado	Riesgo de contaminación de aguas subterráneas
Apropiado cuando no hay intención de reutilización de aguas grises	Requiere un área de gran
Recarga de aguas subterráneas	Materiales de construcción no pueden ser disponibles a nivel local
Fácil de usar / seguro que subterráneos	Requiere experto en diseño y construcción

<b>Limitaciones</b>
El suelo debe permitir la filtración
Se deben construir por lo menos 30 metros de cualquier fuente de agua potable
La zona geográfica debe tener un bajo nivel del suelo y estar expuesto al sol
No se debe utilizar para grandes volúmenes diarios de aguas grises
Los árboles y las plantas con raíces profundas deben mantenerse alejados del área de construcción

### **Construcción:**

1. Las zanjas construir
  - a. Cada zanja debe ser excavada medir de 0,3 a 1,5 m de profundidad y 0,3-1 m de ancho
    - i. Puede ser excavado manualmente

- b. La zanja debe medir al menos 20 metros de largo y deberá tener 2.1 m de distancia
  - c. Llene cada zanja de unos 0,15 m de grava
    - i. La grava deberá tener un diámetro de 20-50 cm de diámetro, preferiblemente
  - d. Los tubos perforados de distribución debe ser establecida en la parte superior de la grava
  - e. Se deberá agregar una capa adicional de grava de 150 cm de espesor , para cubrir las tuberías
  - f. Los tubos deben ser enterrados a 150 cm de la superficie del suelo
  - g. Debe añadirse una capa geotextil para prevenir la obstrucción de las tuberías debido a pequeñas partículas
  - h. La zanja se debe cubrir con tierra hasta el nivel del suelo
2. Tubería perforada
- a. Las tuberías deben ser tuberías de cerámica de alcantarillado de 0,1 m de diámetro
3. Caja de distribución (opcional)
- a. Dirige el agua hacia los canales diferentes por eléctrico o gravedad
4. Mantenimiento
- a. Hay muy poco mantenimiento requerido ya que el sistema es subterráneo
  - b. No debe haber plantas o árboles sobre el sistema y deberá haber tráfico pesado
  - c. Si la obstrucción se produce (lo que sucederá después de un largo período de tiempo) las tuberías deberán ser limpiadas o eliminadas y ser reemplazadas

## Filtro de Arena

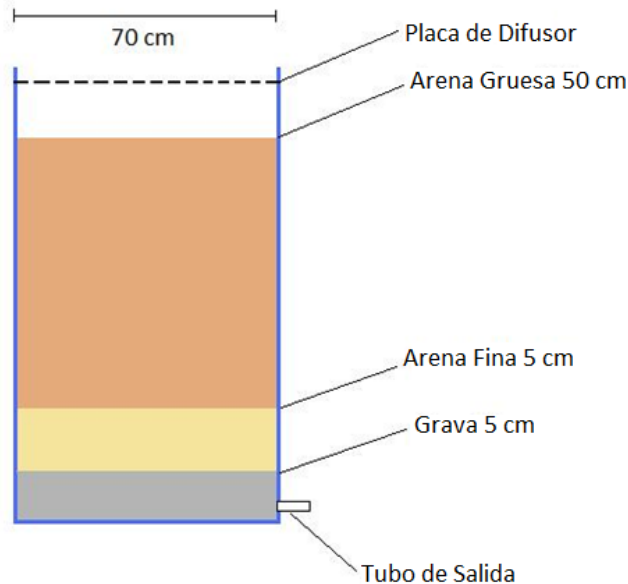

**Filtro de arena**

Los filtros de arena son ideales para las zonas donde las aguas grises pueden ser reutilizadas. El concepto básico del sistema es filtrar las aguas grises a través de capas de materiales granulados, como grava y arena. Los microbios y otras partículas se eliminan del agua por el material granulado. El diseño del sistema depende de la preferencia del usuario. La cantidad de agua se debe tomar en cuenta en la construcción de un filtro de arena. Los filtros de arena pueden ser comprados o contruidos de forma manual. Se recomienda que el agua residual a ser tratados previamente con una trampa de grasa (ver tanque séptico).

<b>Información Básica</b>	
Coste medio de implementación	∅67.000 CRC
El coste medio anual de mantenimiento	∅0 CRC
Facilidad de implementación	Fácil
Facilidad de mantenimiento	Fácil
Eficiencia	Alto
Tamaño	Varía, este ejemplo utiliza 55 - tambor de aceite por galón
Duración de vida	10-20 años

<b>Ventajas</b>	<b>Desventajas</b>
No hay riesgo de contaminación de aguas subterráneas	Obstrucciones frecuentes
De fácil construcción con materiales locales	El mantenimiento regular
Variedad de materiales pueden ser utilizados	Riesgo de problemas de olores
La calidad alta de agua tratada	Pre-tratamiento se requiere
Bajo nivel de habilidades requeridas para la construcción y operación	
El agua tratada puede ser reutilizada	

## **Construcción**

Hay muchos diseños diferentes que se pueden utilizar. Los componentes más importantes de un filtro de arena es un contenedor que tiene una entrada en la parte superior y salida en la parte inferior, una capa de arena, una capa de grava fina y una capa de grava gruesa. También debe tener una placa difusora que distribuye el agua suavemente y uniformemente sobre la parte superior de la arena.

1. Contenedor y la tubería
  - a. Contenedor hermético
    - i. 250 L bidón de plástico se debe utilizar
    - ii. Debe tener un interior limpio antes de que el material de grava y granular se añaden
    - iii. Perforar un agujero de salida en la parte inferior del contenedor, de 2 cm de la base
      1. El agujero debe ser de una pulgada (2,54 cm) de diámetro
2. El tubo
  - a. El tubo puede estar hecho de PVC que es una pulgada (2,54 cm) de diámetro
  - b. Conecte pezón-codo toma de tubería atornillando a la batería en la parte inferior del contenedor y la conexión a la PVC
  - c. Una malla de mosquitos pequeño debe ser colocado en el agujero de salida en el interior del tambor para que no piezas de grava viajan a través del tubo de salida y bloquear la apertura
  - d. El filtro de arena debe ser levantado con bloques de hormigón o de madera para permitir un depósito colector para recoger el agua de la tubería de salida
3. Medio de filtro

- a. Lave la arena antes de colocarlo en el contenedor
    - i. Se puede lavar por llenando el recipiente con arena y luego con agua limpia
    - ii. Arena y el agua se debe mezclar en el recipiente, el agua debe ser vertida a cabo
    - iii. Repita hasta que el agua salga clara
  - b. La batería debe estar lleno de (ver figura 11):
    - i. Primero, coloque una capa de 5 cm de grava gruesa
    - ii. Segundo, coloque una capa de 5 cm de arena fina
    - iii. Finalmente, coloque una capa de 50 cm de arena gruesa
4. Placa de difusor
- a. La placa de difusor distribuye el agua uniformemente que entra en el filtro para asegurar que el agua no salpica y perturbar la arena
  - b. Coloque la placa de difusor 10 cm por encima de la capa superior de arena
  - c. Debe ser una placa circular que es de 70 cm de diámetro
  - d. Se puede hacer de un contenedor de plástico perforado o una hoja de metal inoxidable
  - e. Debe ser desmontable
5. Mantenimiento
- a. El filtro debe ser limpiado regularmente
  - b. Al añadir las aguas residuales en el filtro, debe ser poco a poco se vierte sobre la placa de difusor

## Glosario

**Agua negro:** Las aguas residuales que contienen corporales u otros desechos biológicos, como de los inodoros, lavadoras de platos, o desagües de la cocina

**Aguas residuales:** Agua que se ha utilizado, como para el lavado, enjuague, o en un proceso de fabricación, por lo que contiene productos de desecho

**De aguas residuales:** El contenido de una alcantarilla o drenaje, se niegan líquidos o material arrastrado por las alcantarillas

**Aguas subterráneas:** El agua que se acumula o fluye por debajo de la superficie de la tierra, llenando los espacios porosos en el suelo, los sedimentos y rocas. Las aguas subterráneas provienen de la lluvia y del derretimiento de la nieve y el hielo y es la fuente de agua de los acuíferos, manantiales y pozos

**Anaeróbica:** Que se refieran o causada por la ausencia de oxígeno

**Berma:** Un montículo o banco de tierra, que se utiliza sobre todo como una barrera o para proporcionar un aislamiento

**Compost:** Una mezcla de varias sustancias orgánicas en descomposición, como las hojas muertas o estiércol, que se utiliza para fertilizar el suelo.

**Compostaje:** Para convertir (materia vegetal) para abono

**Eficiencia:** Logro de la capacidad o para ejecutar un trabajo con un gasto mínimo de tiempo y esfuerzo

**Efluentes:** Se trata de unos líquidos resultantes del almacenamiento y tratamiento de aguas residuales y excretas que ya se ha sometido a un tratamiento parcial o completo. Dependiendo del nivel de tratamiento que ya se aplican, que puede ser utilizado o dado de alta, o tienen que someterse a un tratamiento posterior.

**Eliminación:** El acto o los medios de deshacerse de algo

**Escoria:** Una capa transparente de una materia extraña o impuro que se forma sobre o sube a la superficie de un líquido o cuerpo de agua.

**Escorrentía:** Algo que los desagües o en los flujos de, en forma de lluvia que escurre de la tierra en los arroyos

**Excretas:** La materia de desecho, tales como orina, heces o el sudor, el alta del cuerpo  
Las aguas grises: las aguas residuales producidas por la actividad humana, tales como baños y duchas, lavadoras de ropa, y los baños.

**Infraestructura:** Las instalaciones y sistemas fundamentales que sirven de un país, ciudad o área, como los sistemas de transporte y comunicación, centrales eléctricas, y las escuelas.

**Letrina:** Un recipiente (como un hoyo en la tierra) para su uso como un inodoro

**Lodos:** Material semisólido como el precipitado tipo de tratamiento de aguas residuales

**Mejores servicios de saneamiento:** Servicios de saneamiento mejorados se define como aquella que separa higiénicamente las excretas humanas del contacto humano

**Municipales:** La reunión del gobierno de residuos sólidos y materiales reciclables y su transporte hasta el lugar donde se vacía el vehículo de recolección

**Obstrucción:** Impedir u obstaculizar con la materia espesa y pegajosa; nudo en la garganta

**Patógeno:** Un agente que causa la enfermedad, especialmente un microorganismo vivo, como una bacteria o un hongo

**Percolación:** Para hacer que (el líquido, por ejemplo) para pasar a través de una sustancia porosa o agujeros pequeños; filtro

**pH:** La acidez o alcalinidad de una solución en una escala de 0 a 14, donde menos del 7 representa la acidez, neutralidad 7, y la alcalinidad más de 7.

**Reciclable:** Capaz de ser utilizado de nuevo

**Reciclaje:** Para el tratamiento o proceso (utilizado o los residuos) para hacer aptos para su reutilización

**Residuos orgánicos:** Los residuos orgánicos se componen de los residuos de origen biológico, tales como papel y cartón, alimentos, verdes y residuos de jardinería, residuos animales y biosólidos y lodos

**Residuos sólidos:** Los sólidos o semisólidos, material insoluble (incluidos los gases y líquidos en contenedores), tales como rechazar la agricultura, los residuos de demolición, residuos industriales, residuos de la minería, la basura municipal, y lodos de depuradora.

**Saneamiento:** La promoción de la higiene y la prevención de enfermedades mediante el mantenimiento de las condiciones sanitarias (como por la eliminación de aguas residuales y basura)



**Superficie del agua:** El agua, naturalmente, abierto a la atmósfera, el agua de los estuarios, lagos, lagunas, embalses, ríos, y mares

**Tabla de las aguas subterráneas:** El límite superior del cuerpo de suelo saturado

**Ventilación:** Un sistema o un medio para proporcionar aire fresco

## Referencias

- Calvert, P. (2005). Compost toilets. Warwickshire, UK: The Schumacher Centre for Technology & Development. [Online]
- Chatterton, K. (2002). Emergency sanitation: Assessment and programme. Design, Water, Engineering and Development Centre Loughborough University. Retrieved from <http://helid.digicollection.org/en/d/Js2669e/1.html>
- Davis, M. L., & Masten, S. J. (2009). Wastewater treatment. In Principles of Environmental Engineering and Science (Second Edition ed., pp. 457-481). New York, NY: McGraw-Hill.
- DuPoldt, C., Edwards, R., Garber, L., Isaacs, B., Lapp, J., Murphy, T., Webster, H. (1994). A handbook of constructed wetlands. Washington, D.C.: United States Government Printing Office. [Online]
- Frenoux, C., Gabert, J., Guillaume, M., & Monvois, J. (2011). How to select appropriate technical solutions for sanitation. Cotonou and Paris: Partenariat pour le Développement Municipal (PDM) and Programme Solidarité Eau (pS-Eau). [Online]
- Huuhtanen, S., & Laukkanen, A. (2006). A guide to sanitation and hygiene for those working in developing countries. Tampere, Finland: Tampere Polytechnic University of Applied Sciences Publications. [Online]
- Lüthi, C., Morel, A., Schertenleib, R., Tilley, E., & Zurbrügg, C. (2008). Compendium of sanitation systems and technologies. (Report No. 978-3-906484-44-0). Switzerland: Eawag-Sandec. [Online]
- Minnesota Small Urban Sites. (2001). Infiltration trenches. Barr Engineering Company. [Online]
- Rural Africa Water Development Project. (2011). Mor-sand filter. Retrieved December 1, 2011, from: [http://www.rawdp.org/Home\\_Page.html](http://www.rawdp.org/Home_Page.html)
- Shaw, R. (2002). Emergency sanitation: Assessment and programme design. Water, Engineering and Development Centre Loughborough University. Retrieved from <http://helid.digicollection.org/en/d/Js2669e/1.html>
- Torfaen County Borough Council. (2010). Composting [Diagram], Retrieved November 28, 2011, from

<http://www.torfaen.gov.uk/EnvironmentAndPlanning/RubbishWasteAndRecycling/Composting/Images/How%20Compost%20Happens.gif>

- US EPA. (1998). Constructed wetlands design manual (Report No. EPA/625/1-88/022). Washington, D.C.: Office of Research and Development. [Online]
- US EPA. (1999a). Storm water technology fact sheet infiltration trench. (Report No. EPA 832-F-99-019). Washington, D.C.: Office of Water. [Online]
- US EPA. (1999b). Wastewater technology fact sheet intermittent sand filters. (Report No. EPA 932-F-99-067). Washington, D.C.: Office of Water. [Online]
- US EPA. (1999c). Water efficiency technology fact sheet composting toilets. (Report No. EPA 832-F-99-066). Washington, D.C.: Office of Water. [Online]
- US EPA. (2002). A homeowner's guide to septic systems. (Report No. EPA-832-B-02-005). Washington, D.C.: Office of Water. [Online]
- US EPA. (2004). Constructed treatment wetlands. (Report No. EPA 843-F-03-013). Washington, D.C.: Office of Water. [Online]
- US EPA. (2011a). Resource conservation: Composting. Retrieved from <http://www.epa.gov/osw/conserves/rrr/composting/basic.htm>
- US EPA. (2011b). Resource conservation: Recycling. Retrieved from <http://www.epa.gov/osw/conserves/rrr/recycle.htm>
- WHO. (1996). Fact sheets on environmental sanitation. Geneva, Switzerland: WHO Press. [Online]
- Wolfgang, B., Deutsche gesellschaft für technische zusammenarbeit (2010). Basic Overview of Composting Toilets. Retrieved December 4, 2011 from: <http://www.gtz.de/en/dokumente/gtz2010-en-technology-review-composting-toilets.pdf>
- Wright, M., (1996). Safe use of household greywater. Las Cruces, New Mexico: New Mexico State University. [Online]